

Ultrasonic Transducers

For Flaw Detection and Sizing



www.gesensinginspection.com



imagination at work



©2008 GE. All rights reserved.
GEIT-20117EN (04/08)

Table of Contents

Transducer Selection Criteria and Performance	2
General Information—Contact Inspection and Immersion Methods	2
Transducer Selection Criteria—European Standards	3
Transducer Selection Criteria—North American Standards	4
Contact Transducers	5
Straight Beam Contact Transducers, Protective Face	5
European	
North American	
Straight Beam Contact Transducers, Wear Resistant	8
European	
North American	
Straight Beam Contact Transducers, Delay Line	12
European	
North American	
Straight Beam Contact Transducers, Dual Element (TR)	15
European	
North American	
Angle Beam Transducers—Large Sizes	18
European	
North American	
Angle Beam Transducers—Small Sizes	22
European	
North American	
Angle Beam Transducers—Dual Element (TR)	28
Immersion Transducers	31
European	32
North American	33
Transducers for Specific Applications	35
Special Application Transducers	35
Phased Array Transducers	36
Transducer Accessories	37
Cables and Adapters	37
Couplants	38
Calibration Blocks	39
Transducer Kits	40
Transducer Certification	41
Tables and Formulas	43

Transducer Selection Criteria and Performance

General Information

The ultrasonic transducers in this catalog are divided into two general categories, Contact and Immersion.

Transducers for the Contact Inspection Method

Straight Beam—Single Element

- Parts with regular geometry and relatively smooth contact surface
- Flat or curved contact surface
- Flaw or backwall parallel to surface or detectable with beam normal to surface
- Preferred for penetration of thick sections
- Delay line types improve near surface resolution
- Requires couplant layer, typically a gel, oil, or paste
- Typically used for manual inspection

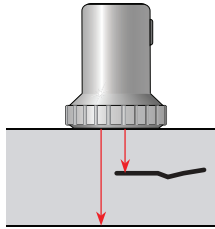

Straight Beam—Dual Element (TR)

- Transmit and receive elements separated by crosstalk barrier
- Flaw or backwall parallel to surface or detectable with beam normal to surface
- Best for thin sections, near surface resolution
- Requires couplant layer, typically a gel, oil, or paste
- Typically used for manual inspection

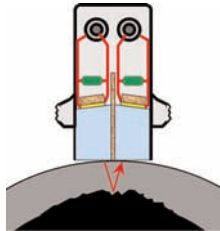

Angle Beam

- Element mounted on integral or replaceable wedge
- Uses refraction to transmit shear or longitudinal wave at a predetermined angle
- Most standard transducers generate shear waves by mode conversion
- Preferred for parts with inclined flaws, such as welds
- Available in both single and dual element types
- Requires couplant layer, typically a gel, oil, or paste
- Sometimes used in mechanized or automated testing

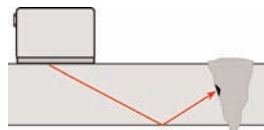

Transducers for the Immersion Method

Immersion Transducers

- Acoustically matched for best efficiency in water
- Suitable for parts with irregular geometries
- Commonly used in mechanized or automated testing
- Best method for consistent coupling and reproducible results
- Large parts can be tested using probe holders, bubblers, or water jets
- Transducers can be focused to improve results

Focused Immersion Transducers

- Spherical focus forms a point or spot
- Cylindrical focus forms a line

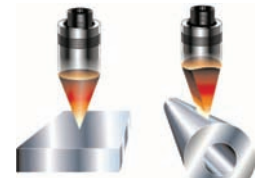

Spherical (Spot, Point) Focus Cylindrical (Line) Focus

Advantages of Focusing

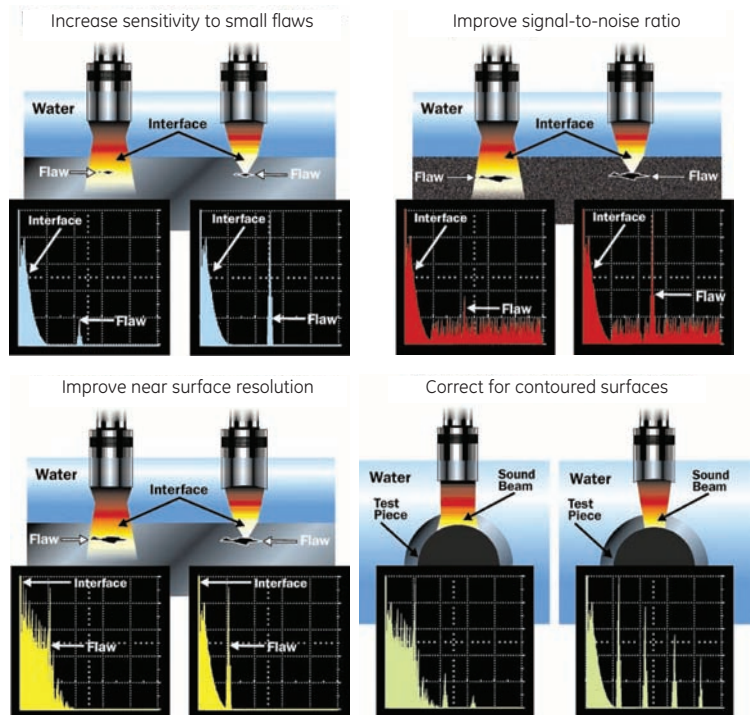

Transducer Selection Criteria—European Standards

For transducers manufactured to European standards, technical and performance information is provided throughout this catalog based on the definitions below. A comprehensive data sheet is supplied with most flaw detection transducers at no charge.

Description	Explanation
Element size D or a x b	Diameter D or length x width a x b of the transducer element. The size of the element strongly affects the shape of the transmitted sound field. Slight deviations, (e.g., imperfect shape or positions with reduced radiation due to poor bonding) cause considerable evaluation errors, even when calibrated to a reference flaw.
Nominal frequency f	The mean frequency of all probes of the same type. The frequency has a great influence on the evaluation of reflectors. Even the shape of the sound field and the reflection behaviour of angled reflectors are strongly dependent on the frequency. With increasing frequency, the echo height from non-vertically positioned reflectors to the sound beam decreases. This is why each probe is checked by our Quality Control to see if its frequency coincides with the nominal frequency, according to the identification label, within very narrow tolerances. This is entered into the probe data sheet.
Bandwidth B	<p>The range of frequencies in the echo pulse whose amplitude, at the most, is 6 dB less than the maximum amplitude.</p> $B = \frac{f_o - f_u}{f} \times 100\%$ <p>f_o = upper, f_u = lower frequency limit for a 6 dB drop in amplitude. With B = 100%, a 4 MHz, probe for example, has an f_o of 6 MHz and an f_u of 2 MHz. Large bandwidths mean shorter echo pulses, which mean high resolution and a good penetration power, because the lower frequencies of the pulse become less attenuated than the nominal frequency. At high attenuation, the frequency of reflected signals decreases, compared to the nominal frequency, as the distance increases. This must be taken into account with flaw evaluation. The bandwidth of each probe is therefore checked and must, within narrow tolerances, coincide with the mean value of all probes.</p>
Focal distance F	The distance of a small reflector from the probe producing the highest possible echo. Probes are focused in order to detect small reflectors and produce a high echo amplitude. Focusing is only possible within the near field of the probe.
Near field length N	<p>The near field length N is the focal distance of the unfocused probe which constitutes the sound pressure maximum at the largest distance from the probe. N is determined by D, c and f.</p> $\text{For } D \gg \lambda \text{ is: } N = \frac{D^2_{\text{eff}}}{4\lambda} = \frac{D^2_{\text{eff}} \cdot f}{4c}$ <p>λ = wave length c = sound velocity D_{eff} = effective element diameter Focal point and near field length are the distances with the best sound concentration and reflector recognition. Therefore, when a probe is selected for a critical test, the flaw expectancy range must be in the focal area or near field length. The data in the tables refers to steel with the exception of immersion testing in water.</p>
Focal diameter FD_6	<p>Diameter of the sound field in the focal distance or near field length with a 6 dB drop of the echo indication.</p> $\text{For } D \gg \lambda \text{ is: } FD_6 = \frac{F \cdot c}{f - D_{\text{eff}}} = \frac{1}{4} k \cdot D_{\text{eff}} \quad \text{with } k = \frac{F}{N}$
Pulse shape	The presentation of signals, as they are at the instrument input coming from plane reflectors.
Spectrum	Display of all the frequencies in the echo pulse. The frequency amplitudes are shown over the frequency.
Beam angle B	The angle between the main beam and the normal axis of the test surface.

Transducer Selection Criteria—North American Standards

For transducers manufactured to North American standards, GE Inspection Technologies offers three performance ranges: **Alpha**, **Benchmark**, and **Gamma Series**. Waveform and frequency certification, per ASTM E-1065, are supplied with all flaw detection transducers at no charge.

Alpha Series Features

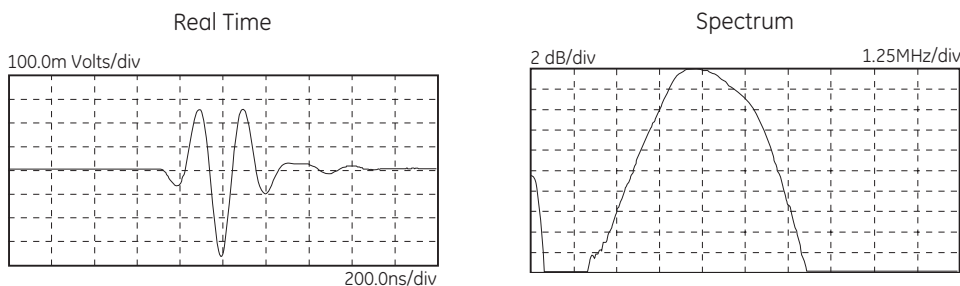

- Recommended for applications where resolution is the primary consideration.
- Suitable for applications such as thickness measurement and near-surface flaw detection.
- Very short pulse—mechanically damped to the limit of current technology.
- Gain is usually lower than that of the Gamma and Benchmark Series.
- Broadband—typical 6 dB bandwidths range from 50% to 100%.
- Typical Alpha waveforms (right) exhibit one to two full ring cycles, depending on frequency, size and other parameters.

Benchmark Series Features

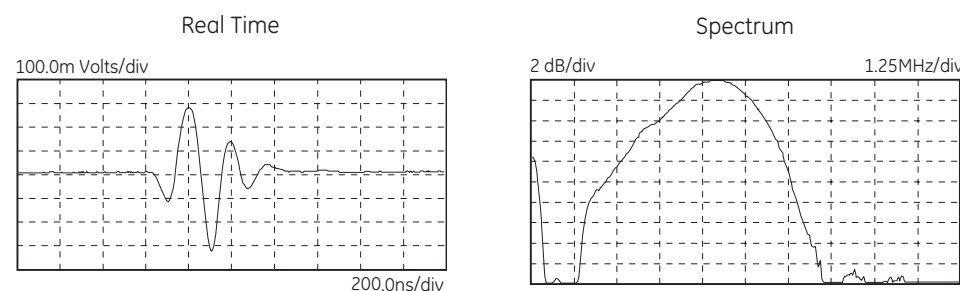

- Proprietary **BENCHMARK COMPOSITE®** (piezocomposite) active elements.
- Penetration in attenuative materials is far superior to conventional transducers.
- High signal to noise on coarse grain metals, fiber reinforced composites, et al.
- Short pulse—resolution usually superior to Gamma Series.
- Gain is usually higher than that of the Gamma and Alpha Series.
- Very broadband—typical 6 dB bandwidths range from 60% to 120%.
- Low acoustic impedance element improves performance of angle beam, delay line, and immersion probes—excellent match to plastic and water.

Gamma Series Features

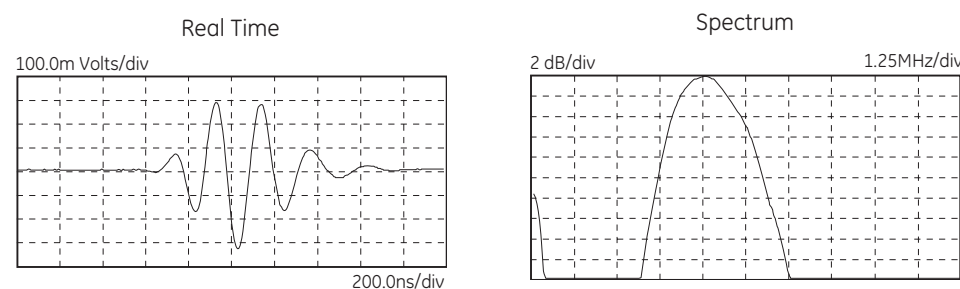

- General purpose transducers, recommended for the majority of applications.
- Medium pulse, medium damping—best combination of gain and resolution.
- Matching electrical network ensures maximum gain and optimum waveform for general use.
- Medium bandwidth—typical 6 dB bandwidths range from 30% to 50%.
- Typical Gamma waveform exhibits three to four full ring cycles, depending on frequency, size and other parameters.

Contact Transducers

Straight Beam Contact Transducers, Protective Face



Applications

- General purpose, larger parts with simple geometry
- Forgings, billets
- Plates, bars, square profiles
- Containers, machine components, shells
- Inspection at high temperature with delay line

Features and Benefits

- European models have replaceable membrane:
 - Improves coupling on uneven or curved surface
 - Extends transducer life.
 - Suitable for DGS flaw sizing method
 - High temperature delay lines also available
 - Lemo 1 (B..S) or Lemo 00 (MB..S) connector, side mount standard, top mount optional
- North American models can be used with three types of protective face:
 - Membrane improves coupling on uneven or curved surface.
 - Wear cap extends transducer life indefinitely when replaced periodically.
 - High temperature delay line enables testing on surfaces up to 400°F (200°C).
 - BNC connector, side or top mount

Protective Face Transducers—European Standards



B.S



MB.S

Types B..S and MB..S

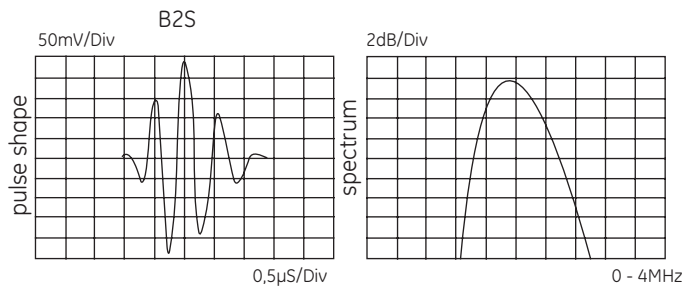

Typical waveform and frequency spectrum

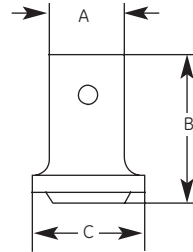

Case Type	A		B		C	
	mm	in	mm	in	mm	in
Type 2	30	1.18	59	2.32	45	1.69
Type 3	20	0.79	43	1.77	25	0.98

Type	Order Code	D		f (MHz)	N		Notes	Sketch
		mm	in		mm	in		
B 1 S	57744	24	0.94	1	23	0.9		Type 2
B 1 S-EN	500035	24	0.94	1	23	0.9	DIN EN 12668-2 compliant	
B 1 S-O	57755	24	0.94	1	23	0.9	Top connector	
B 2 S	57745	24	0.94	2	45	1.8		
B 2 S-EN	500036	24	0.94	2	45	1.8	DIN EN 12668-2 compliant	
B 2 S-O	57756	24	0.94	2	45	1.8	Top connector	
B 2 S-O-EN	500267	24	0.94	2	45	1.8	DIN EN 12668-2 compliant, top connector	
B 4 S	57746	24	0.94	4	88	3.5		
B 4 S-EN	500037	24	0.94	4	88	3.5	DIN EN 12668-2 compliant	
B 4 S-O	57757	24	0.94	4	88	3.5	Top connector	
B 4 S-O-EN	500268	24	0.94	4	88	3.5	DIN EN 12668-2 compliant, top connector	
B 5 S	57747	24	0.94	5	110	4.3		
MB 2 S	57748	10	0.39	2	8	0.3		Type 3
MB 2 S-EN	500038	10	0.39	2	8	0.3	DIN EN 12668-2 compliant	
MB 2 S-O	57975	10	0.39	2	8	0.3	Top connector	
MB 4 S	57749	10	0.39	4	16	0.6		
MB 4 S-EN	500039	10	0.39	4	16	0.6	DIN EN 12668-2 compliant	
MB 4 S-O	57976	10	0.39	4	16	0.6	Top connector	
MB 5 S	57750	10	0.39	5	20	0.8		
MB 5 S-O	57977	10	0.39	5	20	0.8	Top connector	

Custom configurations are available by special order.

For explanations to the table data, refer to Selection Criteria on pages 2 through 4.

Accessories

Description	Type	Remark
Protective membrane (1 set = 10 pcs)	ES45 (53756) ES24 (53769)	for B..S; for MB..S;
Delay line or delay wedges	Special order	e.g., for testing at high temperatures.
Cables	PKLL2 (50326) MPKLL2 (50486)	for B..S for MB..S

Protective Face Transducers—North American Standards

Element Ø		A		B		C	
mm	in	mm	in	mm	in	mm	in
13	0.50	19.1	0.75	30.5	1.20	23.9	0.94
19	0.75	25.4	1.00	30.5	1.20	30.2	1.19
25	1.00	31.8	1.25	30.5	1.20	36.6	1.44

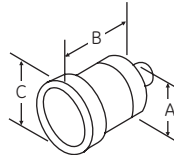

Protective Face Combination Transducers—Type PFCR (Side Mount BNC), PFCS (Top Mount BNC)

Freq. (MHz)	Element Ø		Order Code		Freq. (MHz)	Element Ø		Order Code	
	mm	in	Gamma Series PFCR	Gamma Series PFCS		mm	in	Gamma Series PFCR	Gamma Series PFCS
1.0	13	0.50	241-240	241-260	3.50	13	0.50	243-240	243-260
	19	0.75	251-240	251-260		19	0.75	253-240	253-260
	25	1.00	261-240	261-260		25	1.00	263-240	263-260
2.25	13	0.50	242-240	242-260	5.0	13	0.50	244-240	244-260
	19	0.75	252-240	252-260		19	0.75	254-240	254-260
	25	1.00	262-240	262-260		25	1.00	264-240	264-260

Note: Protective face option kits sold separately. Custom configurations are available by special order.

Protective Face Option Kits—PFCR/PFCS

Kit Styles	Order Code		
	Transducer Element Ø		
	.5 in (13 mm)	.75 in (19 mm)	1.00 in (25 mm)
PM	118-450-120	118-450-140	118-450-160
PWC	118-450-220	118-450-240	118-450-260
PHTD - 1.0 in (25.4 mm) Delay	118-450-320	118-450-340	118-450-360
PHTD - 1.5 in (38.1 mm) Delay	118-450-420	118-450-440	118-450-460

Style PM Kit includes a knurled ring, gland nut, wrench, 12 membranes, and a 2 oz. bottle of couplant (transducer not included).

Style PWC Kit includes a knurled ring, three wear caps, and a 2 oz. bottle of couplant (transducer not included). This option may not be usable if near surface resolution is critical.

Style PHTD Kit includes a knurled ring, high temperature delay line, and a 2 oz. bottle of couplant (transducer not included).

	Order Code		
	Transducer Element Ø		
	.5 in (13 mm)	.75 in (19 mm)	1.00 in (25 mm)
Spare Membranes pkg. of 12 pcs.	118-220-020	118-220-021	118-220-022
Spare Wear Caps pkg. of 12 pcs.	118-240-123	118-240-122	118-240-121
Hi-Temp. Delay Line* 1.0 in (25.4 mm) length	118-440-027	118-440-031	118-440-035
Hi-Temp. Delay Line* 1.5 in (38.1 mm) length	118-440-029	118-440-033	118-440-037
BNC Cable	118-140-016		
Membrane, Wear Cap and Delay Line Couplant	118-300-740		

* High Temp (PHTD) delay line: maximum temperature 400°F (200°C), maximum contact time 10 seconds; cool to ambient before reuse.

Straight Beam Contact Transducers, Wear Resistant



Applications

- General purpose, metal parts with simple geometry
- Manual inspection of plate, large forgings, billets, castings
- Smaller models for pipe and tube, tanks, bars, small forgings
- Lamination, delamination
- Bond testing
- Thick sections or difficult to penetrate materials

Features and Benefits

- Permanent, abrasion—resistant wear plate
- Best match to metals
- Higher gain reserve than protective face models
- Fingertip models for access to tight spaces
- Comfortable grip
- European models have side mounted Lemo 00 connectors, side mounted Microdot on K..K and G..K types.
- North American models have BNC connectors (side or top mount), side mounted Microdot on F type.

Wear Resistant Transducers—European Standards



K..G, G..N

K..N, G..KB



K..K, G..K

Types K..G, K..N, K..K, G..N, G..KB and G..K

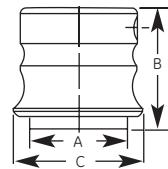
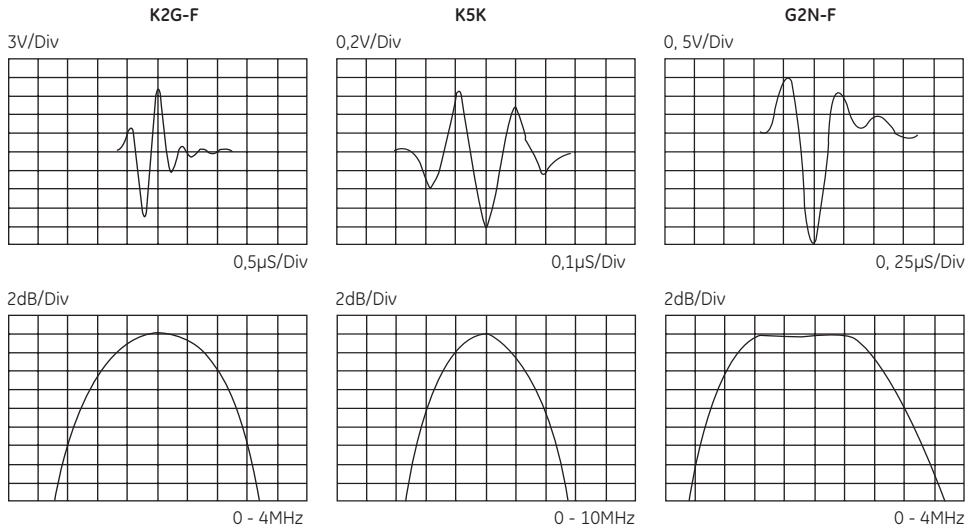

Case Type	A		B		C	
	mm	in	mm	in	mm	in
Type 5	30	1.18	37	1.46	40	1.57
Type 6	15	0.59	31	1.22	26	1.02
Type 7	10	0.39	17	0.67		

Typical waveform and frequency spectrum

Type	Order Code	D	f	N	Notes	Sketch		
		mm	in	(MHz)	mm	in		
K 1 G	58506	24	0.94	1	23	0.9	Type 5	
K 2 G	58507	24	0.94	2	45	1.8		
K 2 G-EN	500071	24	0.94	2	45	1.8		DIN EN 12668-2 compliant
K 4 G	58508	24	0.94	4	88	3.5		
K 4 G-EN	500072	24	0.94	4	88	3.5		DIN EN 12668-2 compliant
K 1 N	67620	10	0.39	1	4	0.2	Type 6	
K 2 N	58509	10	0.39	2	8	0.3		
K 4 N	58510	10	0.39	4	16	0.6		
K 5 N	58511	10	0.39	5	20	0.8		
K 5 K	52831	5	0.20	5	5	0.2	Type 7	
K 5 K-EN	500061	5	0.20	5	5	0.2		DIN EN 12668-2 compliant
K 10 K	52832	5	0.20	10	10	0.4		
K 10 K-EN	500062	5	0.20	10	10	0.4		DIN EN 12668-2 compliant
G 1 N	58500	24	0.94	1	23	0.9	Type 5	
G 2 N	58501	24	0.94	2	45	1.8		
G 4 N	58502	24	0.94	4	88	3.5		
G 2 KB	58503	10	0.39	2	8	0.3	Type 6	
G 5 KB	58504	10	0.39	5	20	0.8		
G 5 K	53057	5	0.20	5	5	0.2	Type 7	
G 10 K	53052	5	0.20	10	10	0.4		

Custom configurations are available by special order.

For explanations to the table data, refer to Selection Criteria on pages 2 through 4.

Accessories

Description	Type	Remark
Probe Cable	MPKL2 (50486)	for K..G, K..N, G..N, and G..KB
	MPKM2 (52999)	for K..K and G..K

Wear Resistant Transducers—European Standards

Types B..F and MB..F

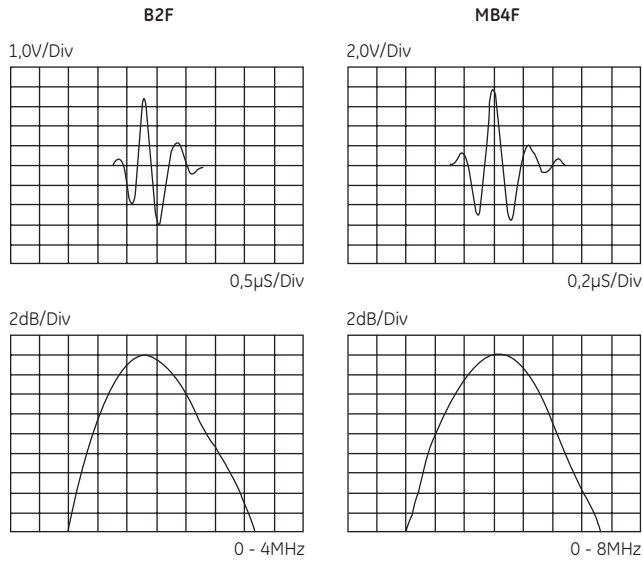

Typical waveform and frequency spectrum

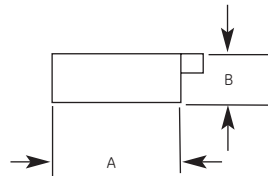

Case Type	A		B	
	mm	in	mm	in
Type 8	31	1.22	16	0.63
Type 9	19	0.75	16	0.63



Type	Order Code	D	f	N	Notes	Sketch		
		mm	in	(MHz)	mm	in		
B 1 F	57899	20	0.79	1	16	0.6	Type 8	
B 2 F	57900	20	0.79	2	31	1.2		
B 4 F	57901	20	0.79	4	62	2.4		
B 5 F	57902	20	0.79	5	76	3.0		
MB 2 F	57904	10	0.39	2	8	0.3	Type 9	
M B 4 F	57905	10	0.39	4	16	0.6		
M B 4 F-EN	500073	10	0.39	4	16	0.6		DIN EN 12668-2 compliant
MB 5 F	57906	10	0.39	5	19	0.8		
MB 10 F	57903	10	0.39	10	32	1.4		

Custom configurations are available by special order.

For explanations to the table data, refer to Selection Criteria on pages 2 through 4.

Accessories

Description	Type	Remark
Cable	MPKL2 (50486)	for B..F and MB..F

Wear Resistant Transducers—North American Standards

Type RHP

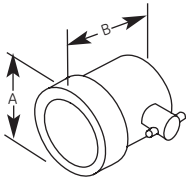

Element Ø		A		B	
mm	in	mm	in	mm	in
13	0.50	29.2	1.15	38.1	1.50
25	0.75	35.6	1.40	38.1	1.50
19	1.00	41.9	1.65	38.1	1.50



Standard Contact Transducers—Type RHP-CR (Side Mount BNC), RHP-CS (Top Mount BNC)

Freq. (MHz)	Element Ø		Order Code			Freq. (MHz)	Element Ø		Order Code		
	mm	in	Alpha Series	Gamma Series	Accessories		mm	in	Alpha Series	Gamma Series	Accessories
.5	19	0.75		250-043-CR 250-123-CS	Cables BNC 118-140-016 LEMO-1 118-140-018	3.5	13	0.50		243-043-CR 243-123-CS	Cables BNC 118-140-016 LEMO-1 118-140-018
	25	1.00		260-043-CR 260-123-CS			19	0.75		253-043-CR 253-123-CS	
1.0	13	0.50		241-043-CR 241-123-CS			25	1.00		263-043-CR 263-123-CS	
	19	0.75		251-043-CR 251-123-CS		5.0	13	0.50	144-043-CR 144-123-CS	244-043-CR 244-123-CS	
25	1.00		261-043-CR 261-123-CS	19			0.75	154-043-CR 154-123-CS	254-043-CR 254-123-CS		
2.25	13	0.50	142-043-CR 142-123-CS	242-043-CR 242-123-CS		10.0	25	1.00	164-043-CR 164-123-CS	264-043-CR 264-123-CS	
	19	0.75	152-043-CR 152-123-CS	252-043-CR 252-123-CS	13		0.50		246-043-CR 246-123-CS		
	25	1.00	162-043-CR 162-123-CS	262-043-CR 262-123-CS							

Custom configurations are available by special order.

Type F

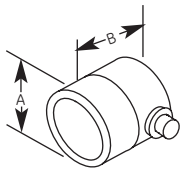

Element Ø		A		B	
mm	in	mm	in	mm	in
6	0.25	12.7	0.50	16.8	0.66
10	0.375	16.0	0.63	16.8	0.66
13	0.50	19.1	0.75	16.8	0.66



Fingertip Contact Transducers—Type F

Freq. (MHz)	Element Ø		Order Code				Freq. (MHz)	Element Ø		Order Code			
	mm	in	Benchmark Series	Alpha Series	Gamma Series	Accessories		mm	in	Benchmark Series	Alpha Series	Gamma Series	Accessories
2.25	6	.250	822-000	122-000	222-000	Cables BNC 118-140-012	5.0	6	.250	824-000	124-000	224-000	Cables BNC 118-140-012
	10	.375	832-000	132-000	232-000			10	.375	834-000	134-000	234-000	
	13	.500	842-000	142-000	242-000			13	.500	844-000	144-000	244-000	
3.5	6	.250		123-000	223-000	LEMO-1 118-140-022	10.0	6	.250		126-000	226-000	LEMO-1 118-140-022
	10	.375		133-000	233-000			10	.375		136-000	236-000	
	13	.500		143-000	243-000			13	.500		146-000	246-000	

Custom configurations are available by special order.

Straight Beam Contact Transducers, Delay Line



Applications

- Thickness measurement
- Near surface flaw detection
- Inspection of thin sections
- Curved parts, tubing, pipe
- Composites and plastics
- Turbine blades

Features and Benefits

- Excellent near surface resolution.
- Replaceable delay line—long life and versatility.
- Higher frequencies improve resolution and small flaw detectability.
- All models have side mounted Microdot connector.

Delay Line Transducers—European Standards

Type G..MN

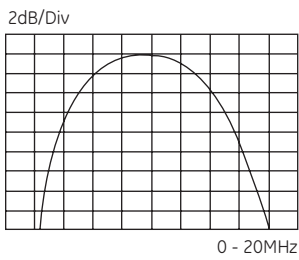
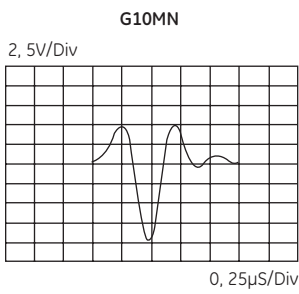

Typical waveform and frequency spectrum

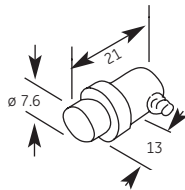

Type	Order Code	D		f	N		Sketch
		mm	in	(MHz)	mm	in	
G 5 MN	53046	5	0.20	5	5	0.2	Type 14
G 10 MN	53047	5	0.20	10	10	0.4	
G 15 MN	53058	5	0.20	15	15	0.6	

Custom configurations are available by special order.

Accessories

Description	Type	Remark
Cable	MPKM2 (52999)	
Delay Line (exchangeable)	CLFV1 (54258) CLFV3 (54262)	.37 in (9.5 mm) for G.MN .49 in (12.5 mm) for G.MN

Delay Line Transducers—North American Standards

Types DFR and K-PEN

Removable Delay Line—Type DFR

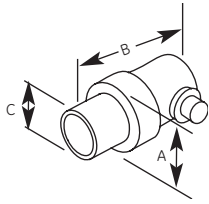

Element Ø		A		B		C	
mm	in	mm	in	mm	in	mm	in
3 or 6	0.125 or 0.25	13	0.51	21.3	0.84	7.6	0.30
13	0.50	22.4	0.88	35.1	1.38	15.2	0.60
Mini-DFR							
3	0.125	10.41	0.41	19.6	0.77	4.8	0.19



K-PEN Replaceable Delay Line Pencil Probe

- Focused, high resolution pencil probe
- Interchangeable delay lines, two tip diameters
- Extremely small contact area
- Tightly curved surfaces, such as turbine blades
- Wall thickness measurement from the bottom of an external pit
- Straight, right angle and 45° handles
- Straight model has removable handle

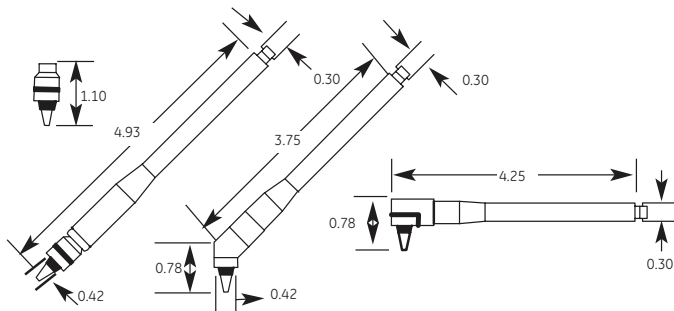

Freq. (MHz)	Element Ø		Alpha Series	Order Codes		Accessories
	mm	in		Delay Line 10-PK .38 in (9.5 mm) Lg	Delay Line 10-PK .5 in (12.7 mm) Lg	
2.25	6	.250	122-660	118-440-050	118-440-051	Cables
	13	.500	140-500		118-440-052	
3.5	6	.250	123-660	118-440-050	118-440-051	BNC 118-140-012
	13	.500	144-660		118-440-052	
5.0	6	.250	124-660	118-440-050	118-440-051	LEMO-1 118-140-022
	13	.500	140-602		118-440-052	
10.0	6	.250	126-660	118-440-050	118-440-051	Delay Line Couplant 118-300-740
	13	.500	140-602		118-440-052	
15.0	6	.250	127-660	118-440-050	118-440-051	Spring Loaded VEE Block 118-480-007
22.0	3	.125	118-660	118-440-050	118-440-051	
Mini-DFR 20.0	3	.125	518-650	118-440-502		

*H-007 fits .125 in (3 mm) and .25 in (6 mm) units only with exception of Mini DFR. Custom configurations are available by special order.

Freq. (MHz)	Order Code					
	Straight K-PEN	45° K-PEN	Right Angle K-PEN	.065 in (1.7 mm) Tip Delay 10-PK	.090 in (2.3 mm) Tip Delay 10-PK	BNC Cable
7.5	389-042-200	389-042-880	389-042-870	387-003-109	387-003-110	118-140-012
20.0	389-030-290	389-041-270	389-040-660			

Straight-Beam Contact Transducers, Dual Element (TR)



Applications

- Remaining wall thickness, corrosion, erosion
- Near surface flaw detection
- Small parts—screws, bolts, pins
- Cladding and weld overlay
- Bond testing
- Railroad wheels
- Core flaws in shafts, bars, billets
- Coarse grain materials

Features and Benefits

- Excellent near surface resolution
- Improved coupling on curved and rough surfaces
- Reduce noise caused by scattering
- Can be contoured for curved parts
- European models have side mounted Lemo 00 connectors, side mounted Microdot SEB..KF types
- North American models have fixed BNC cable (ADP) or side mounted MMD (FDU)

Dual Element (TR) Contact Transducers—European Standards

Types SEB and MSEB

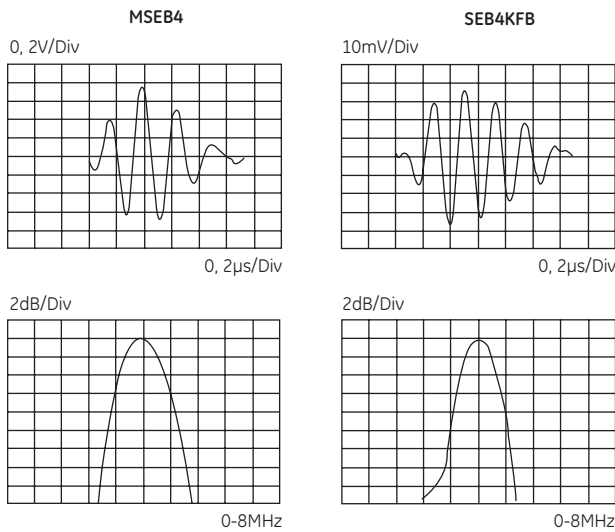
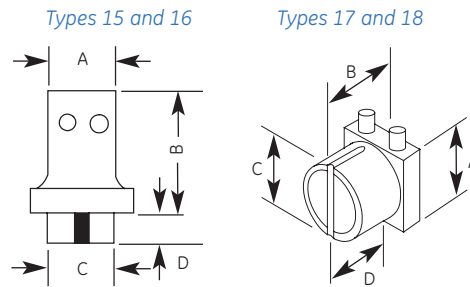

Case Type	A		B		C		D	
	mm	in	mm	in	mm	in	mm	in
Type 15	30	1.18	65	2.56	28.5	1.12	10	0.39
Type 16	20	0.79	45	1.77	16.5	0.65	5	0.20
Type 17	14	0.55	17	0.67	13	0.51	6.4	0.25
Type 18	14	0.55	17	0.67	7.5	0.30	6.4	0.25

Typical waveform and frequency spectrum

Accessories

Type	Order Code	a x b		f (MHz)	F		Notes	Sketch
		mm	in		mm	in		
SEB 1	57466	21 / 2 \varnothing	0.83	1	20	0.8		Type 15
SEB 1-EN	500176	21 / 2 \varnothing	0.83	1	20	0.8	DIN EN 12668-2 compliant	
SEB 2	57467	7 x 18	.28 x .71	2	15	0.6		
SEB 2-EN	500063	7 x 18	.28 x .71	2	15	0.6	DIN EN 12668-2 compliant	
SEB 2-0°	57468	7 x 18	.28 x .71	2	30	1.2	Elements at 0° included angle	
SEB 2-EN-0°	500065	7 x 18	.28 x .71	2	30	1.2	Elements at 0° included angle DIN EN 12668-2 compliant	
SEB 4	57469	6 x 20	.24 x .79	4	12	0.5		
SEB 4-EN	500064	6 x 20	.24 x .79	4	12	0.5	DIN EN 12668-2 compliant	
SEB 4-0°	57470	6 x 20	.24 x .79	4	25	1.0	Elements at 0° included angle	
SEB 4-EN-0°	500066	6 x 20	.24 x .79	4	25	1.0	Elements at 0° included angle DIN EN 12668-2 compliant	
MSEB 2	57461	11 / 2 \varnothing	0.43	2	8	0.3		Type 16
MSEB 2-EN	500067	11 / 2 \varnothing	0.43	2	8	0.3	DIN EN 12668-2 compliant	
MSEB 4	57462	3.5 x 10	.14 x .39	4	10	0.4		
MSEB 4-EN	500068	3.5 x 10	.14 x .39	4	10	0.4	DIN EN 12668-2 compliant	
MSEB 4-0°	57463	3.5 x 10	.14 x .39	4	18	0.7	Elements at 0° included angle	
MSEB 5	57464	9 / 2 \varnothing	0.35	5	10	0.4	Typical bandwidth 100%	
SEB 2 KF5	56464	8 / 2 \varnothing	0.31	2	6	0.24		Type 17
SEB 4 KF8	56465	8 / 2 \varnothing	0.31	4	6	0.24		
SEB 4 KF8-EN	500069	8 / 2 \varnothing	0.31	4	6	0.24	DIN EN 12668-2 compliant	
SEB 5 KF3	56466	8 / 2 \varnothing	0.31	5	3	0.12		Type 18
SEB10 KF3	56867	5 / 2 \varnothing	0.20	10	3	0.12		
SEB10 KF3-EN	500070	5 / 2 \varnothing	0.20	10	3	0.12	DIN EN 12668-2 compliant	

Custom configurations are available by special order.

For explanations to the table data, refer to Selection Criteria on pages 2 through 4.

Description	Type	Remark
Cable	SEKG2 (53887) SEKM2 (53001)	for SEB., MSEB., for SEB..KF

Dual Element (TR) Contact Transducers—North American Standards

Types ADP and FDU

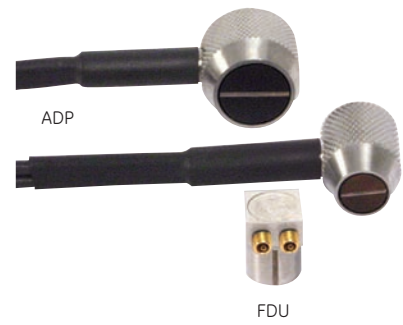
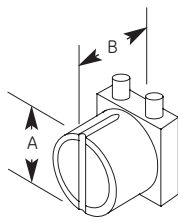
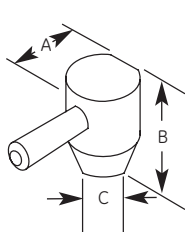

ADP

Element Ø		A		B		C	
mm	in	mm	in	mm	in	mm	in
6	0.25	12.7	.50	16.3	.64	9.1	.36
10	0.375	16.0	.63	16.3	.64	11.9	.47
13	0.50	19.1	.75	17.3	.68	15.2	.60

FDU

Element Ø		A		B	
mm	in	mm	in	mm	in
6	.25	9.7	0.38	12.7	0.50
10	.375	12.7	0.50	12.7	0.50

Dual Element Transducers—Types ADP and FDU

Freq. (MHz)	Element Ø		Order Code		Freq. (MHz)	Element Ø		Order Code	
	mm	in	ADP Dual	FDU Dual†		mm	in	ADP Dual	FDU Dual†
2.25	6	.250	222-700	222-680	5.0	6	.250	224-700	224-680
	10	.375	232-700	232-680		10	.375	234-700	234-680
	13	.500	242-700			13	.500	244-700	
3.5	6	.250	223-700	223-680	7.5	8	.300	135-700	
	10	.375	233-700	233-680	10.0	6	.250	389-002-771	
	13	.500	243-700			13	.500	389-021-830	

† Standard MMD to BNC dual cable (118-140-014) sold separately. Custom configurations are available by special order.

Angle Beam Transducers—Large Sizes



Applications

- General weld inspection, larger objects, thicker sections
- Pipes, tanks, pressure vessels
- Axles, forgings, castings
- Bridges and other structures
- Railroad wheels and rail

Features and Benefits

- European models have integral wedge
 - Maximum precision and repeatability for DGS flaw sizing method
 - Durable, ergonomically designed die cast housing
 - Replacement soles (sold separately) for extended service life
 - Lemo 1 connector on WB and WK types, side mount standard, top mount optional
 - Lemo 00 connector on SWB and SWK types, side mount
- North American models have interchangeable wedges (sold separately)
 - Maximum versatility and service life
 - Custom wedge angles and curvatures can be special ordered
 - AWS models available for AWS Structural Welding Code D1.1
 - High temperature wedges available for testing to 200°C (400°F)
 - BNC connector, top mount

Large Angle Beam Transducers—European Standards

Types WB/WK and SWB/SWK



Types WB/WK and SWB/SWK

Case Type	A		B		C		D	
	mm	in	mm	in	mm	in	mm	in
Type 20	21.5	0.85	37	1.46	31	1.22	3	0.12
Type 21	29	1.14	53.5	2.11	45	1.77	5	0.20

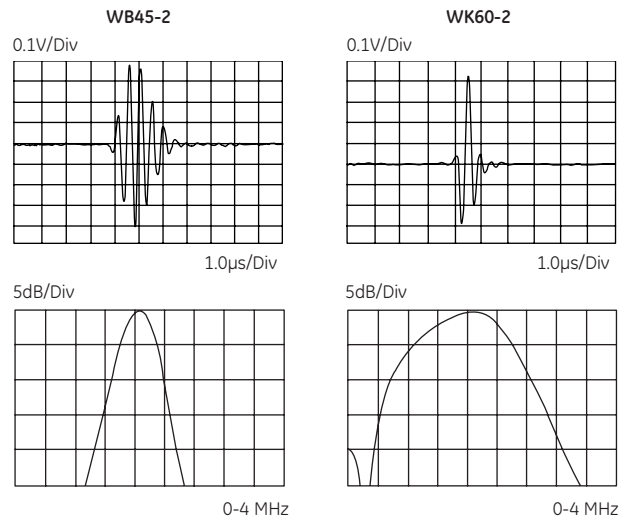
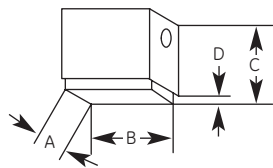

Typical waveform and frequency spectrum

Type	Order Code	a x b		f (MHz)	B (Steel)	N		Notes	Sketch
		mm	in			mm	in		
WB 45-1	56993	20 x 22	.79 x .87	1	45	45	1.8	DIN EN 12668-2 compliant Top connector	Type 21
WB 45-1-EN	500207	20 x 22	.79 x .87	1	45	45	1.8		
WB 45-01	57217	20 x 22	.79 x .87	1	45	45	1.8		
WB 60-1	56994	20 x 22	.79 x .87	1	60	45	1.8	DIN EN 12668-2 compliant Top connector	
WB 60-1-EN	500208	20 x 22	.79 x .87	1	60	45	1.8		
WB 60-01	57218	20 x 22	.79 x .87	1	60	45	1.8		
WB 70-1	56995	20 x 22	.79 x .87	1	70	45	1.8	DIN EN 12668-2 compliant Top connector	
WB 70-1-EN	500209	20 x 22	.79 x .87	1	70	45	1.8		
WB 70-01	57219	20 x 22	.79 x .87	1	70	45	1.8		
WB 35-2	56998	20 x 22	.79 x .87	2	38	90	3.5	DIN EN 12668-2 compliant Top connector	
WB 35-2-EN	500054	20 x 22	.79 x .87	2	38	90	3.5		
WB 35-02	57222	20 x 22	.79 x .87	2	38	90	3.5		
WB 35-02EN	500058	20 x 22	.79 x .87	2	38	90	3.5	DIN EN 12668-2 compliant	
WB 45-2	56999	20 x 22	.79 x .87	2	45	90	3.5	DIN EN 12668-2 compliant Top connector	
WB 45-2-EN	500055	20 x 22	.79 x .87	2	45	90	3.5		
WB 45-02	57223	20 x 22	.79 x .87	2	45	90	3.5		
WB 45-02EN	500059	20 x 22	.79 x .87	2	45	90	3.5	DIN EN 12668-2 compliant	
WB 60-2	57000	20 x 22	.79 x .87	2	60	90	3.5	DIN EN 12668-2 compliant Top connector	
WB 60-2-EN	500056	20 x 22	.79 x .87	2	60	90	3.5		
WB 60-02	57224	20 x 22	.79 x .87	2	60	90	3.5		
WB 60-02EN	500060	20 x 22	.79 x .87	2	60	90	3.5	DIN EN 12668-2 compliant	
WB 70-2	57001	20 x 22	.79 x .87	2	70	90	3.5	DIN EN 12668-2 compliant Top connector	
WB 70-2-EN	500057	20 x 22	.79 x .87	2	70	90	3.5		
WB 70-02	57225	20 x 22	.79 x .87	2	70	90	3.5		
WB 70-02EN	500280	20 x 22	.79 x .87	2	70	90	3.5	DIN EN 12668-2 compliant	
WB 80-2	57002	20 x 22	.79 x .87	2	77	90	3.5	DIN EN 12668-2 compliant Top connector	
WB 80-2-EN	500278	20 x 22	.79 x .87	2	77	90	3.5		
WB 80-02	57226	20 x 22	.79 x .87	2	77	90	3.5		
WB 90-2	57003	20 x 22	.79 x .87	2	90	90	3.5	DIN EN 12668-2 compliant Top connector	
WB 90-2-EN	500266	20 x 22	.79 x .87	2	90	90	3.5		
WB 90-02	57227	20 x 22	.79 x .87	2	90	90	3.5		

Large Angle Beam Transducers—European Standards

Type	Order Code	a x b		f (MHz)	β (Steel)	N		Notes	Sketch
		mm	in			mm	in		
WB 35-4	57004	20 x 22	.79 x .87	4	38	180	7.1	Top connector	Type 21
WB 35-04	57228	20 x 22	.79 x .87	4	38	180	7.1		
WB 45-4	57005	20 x 22	.79 x .87	4	45	180	7.1	DIN EN 12668-2 compliant Top connector	
WB 45-4-EN	500200	20 x 22	.79 x .87	4	45	180	7.1		
WB 45-04	57229	20 x 22	.79 x .87	4	45	180	7.1		
WB 60-4	57006	20 x 22	.79 x .87	4	60	180	7.1	DIN EN 12668-2 compliant Top connector	
WB 60-4-EN	500201	20 x 22	.79 x .87	4	60	180	7.1		
WB 60-04	57230	20 x 22	.79 x .87	4	60	180	7.1		
WB 70-4	57007	20 x 22	.79 x .87	4	70	180	7.1	DIN EN 12668-2 compliant Top connector	
WB 70-4-EN	500202	20 x 22	.79 x .87	4	70	180	7.1		
WB 70-04	57231	20 x 22	.79 x .87	4	70	180	7.1		
WB 80-4	57008	20 x 22	.79 x .87	4	77	180	7.1	Top connector	
WB 80-04	57232	20 x 22	.79 x .87	4	77	180	7.1		
SWB 45-2	58414	14 x 14	.55 x .55	2	45	39	1.5		Type 20
SWB 60-2	58415	14 x 14	.55 x .55	2	60	39	1.5		
SWB 70-2	58416	14 x 14	.55 x .55	2	70	39	1.5		
SWB 45-5	58420	14 x 14	.55 x .55	5	45	98	3.9		
SWB 60-5	58421	14 x 14	.55 x .55	5	60	98	3.9		
SWB 70-5	58422	14 x 14	.55 x .55	5	70	98	3.9		
WK 45-1	67889	20 x 22	.79 x .87	1	45	45	1.8	Piezocomposite element	Type 21
WK 60-1	67890	20 x 22	.79 x .87	1	60	45	1.8		
WK 70-1	67891	20 x 22	.79 x .87	1	70	45	1.8		
WK 45-2	57011	20 x 22	.79 x .87	2	45	90	3.5		
WK 60-2	57012	20 x 22	.79 x .87	2	60	90	3.5		
WK 70-2	57013	20 x 22	.79 x .87	2	70	90	3.5		
SWK 45-2	58843	14 x 14	.55 x .55	2	45	39	1.5	Piezocomposite element	Type 20
SWK 60-2	58844	14 x 14	.55 x .55	2	60	39	1.5		
SWK 70-2	58845	14 x 14	.55 x .55	2	70	39	1.5		

Custom configurations are available by special order.

For explanations to the table data, refer to Selection Criteria on pages 2 through 4.

Accessories

Description	Type	Remark
Cable	PKLL2 (50326)	for WB.., WK..
	MPKL2 (50486)	for SWB.., SWK..
Spare sole (1 set = 10 pcs)	WP(E) (57276)	for WB.., WK..
	SWP (58514)	for SWB.., SWK

Large Angle Beam Transducers—North American Standards

Types SWS and AWS

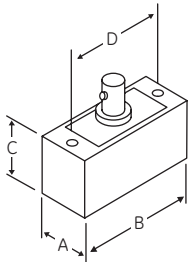

Element Size		A		B		C		D	
mm	in	mm	in	mm	in	mm	in	mm	in
13 Ø	.50 Ø	18.3	.72	25.4	1.00	19.1	.75	20.6	.81
13 x 25	.50 x 1.0	18.5	.725	38.4	1.51	19.1	.75	33.3	1.31
19 x 25	.75 x 1.0	25.4	1.00	38.1	1.5	19.1	.75	33.3	1.31
25 Ø	1.0	31.0	1.22	41.9	1.65	19.1	.75	35.1	1.38
16 x 16	.63 x .63	18.5	.73	31.8	1.25	19.1	.75	25.4	1.00
16 x 19	.63 x .75	18.5	.73	31.8	1.25	19.1	.75	25.4	1.00
19 x 19	.75 x .75	21.6	.85	31.8	1.25	19.1	.75	25.4	1.00



Angle Beam Transducers—Types SWS and AWS

Freq. (MHz)	Element Ø		Order Codes					Freq. (MHz)	Element Ø		Order Codes				
			Gamma Series	Benchmark Series	Standard Wedge (W = 118-340)	Hi-Temp Wedge* (W = 118-340)	Accessories				Gamma Series	Benchmark Series	Standard Wedge (W = 118-340)	Hi-Temp Wedge* (W = 118-340)	Accessories
0.50	25	1.0	260-600		W-021 45°	W-081 45°		2.25 AWS Series	16 x 16	.63 x .63	292-603	892-603	W-104 45°		
					W-022 60°	W-082 60°							W-105 60°		
	W-023 70°	W-083 70°	W-106 70°												
	W-025 90°														
1.0	13	0.5	241-600	841-600	W-009 45°	W-076 45°		3.5	16 x 19	.63 x .75	292-601	892-601	W-104 45°		
					W-010 60°	W-077 60°							W-105 60°		
	W-011 70°	W-078 70°	W-106 70°												
	W-013 90°														
13 x 25	0.5 x 1	291-600	891-600	W-015 45°	W-070 45°		5.0	19 x 19	.75 x .75	292-604	892-604	W-104 45°			
				W-016 60°	W-086 60°							W-105 60°			
W-017 70°	W-071 70°	W-106 70°													
W-019 90°															
2.25	19 x 25	.75 x 1	291-605	891-605	W-051 45°			5.0	13 x 25	0.5 x 1	293-600	893-600	W-009 45°		W-076 45°
					W-052 60°								W-010 60°		
	W-053 70°		W-011 70°	W-078 70°											
	W-054 90°		W-013 90°												
2.25	25	1.0	261-600	861-600	W-021 45°	W-081 45°		5.0	19 x 25	.75 x 1	293-605	893-605	W-051 45°		
					W-022 60°	W-082 60°							W-052 60°		
	W-023 70°	W-083 70°	W-053 70°												
	W-025 90°		W-054 90°												
2.25	13	0.5	242-600	842-600	W-009 45°	W-076 45°		5.0	25	1.0	263-600	863-600	W-021 45°		W-081 45°
					W-010 60°	W-077 60°							W-022 60°		
	W-011 70°	W-078 70°	W-023 70°	W-083 70°											
	W-013 90°		W-025 90°	W-083 70°											
2.25	13 x 25	0.5 x 1	292-600	892-600	W-015 45°	W-070 45°		5.0	13	.5	244-600	844-600	W-009 45°		W-076 45°
					W-016 60°	W-086 60°							W-010 60°		
	W-017 70°	W-071 70°	W-011 70°	W-078 70°											
	W-019 90°		W-013 90°												
2.25	19 x 25	.75 x 1	292-605	892-605	W-051 45°			5.0	13 x 25	.5 x 1	294-600	894-600	W-015 45°		W-070 45°
					W-052 60°								W-016 60°		
	W-053 70°		W-017 70°	W-071 70°											
	W-054 90°		W-019 90°												
2.25	25	1.0	262-600	862-600	W-021 45°	W-081 45°		5.0	19 x 25	.75 x 1	294-605	894-605	W-051 45°		
					W-022 60°	W-082 60°							W-052 60°		
	W-023 70°	W-083 70°	W-053 70°												
	W-025 90°		W-054 90°												
2.25	25	1.0	264-600	864-600	W-021 45°	W-081 45°		5.0	25	1.0	264-600	864-600	W-021 45°		W-081 45°
					W-022 60°	W-082 60°							W-022 60°		
	W-023 70°	W-083 70°	W-023 70°	W-083 70°											
	W-025 90°		W-025 90°	W-083 70°											

* Duty Cycle: at 400°F (200°C), maximum contact time is 10 seconds; cool to ambient before reuse. Note: Standard wedge angles are specified for carbon steel. Custom configurations are available by special order.

Angle Beam Transducers—Small Sizes



Applications

- General weld inspection, smaller objects, thinner sections
- Tubes, pipes, pressure vessels, containers
- Pumps, valve housings
- Turbine blades, shafts
- Wheel rims

Features and Benefits

- European models have integral wedge
 - Maximum precision and repeatability for DGS flaw sizing method
 - Durable, ergonomically-designed die cast housing
 - Replacement soles (sold separately) for extended service life
 - Lemo 00 connector on MWB and MWK types, side mount standard, top mount optional
- North American models have interchangeable wedges (sold separately)
 - Maximum versatility and service life
 - Custom wedge angles and curvatures can be special ordered
 - Both quick change and screw mounted styles available
 - Microdot connector on MSW-QC and MSWS types, MMD on SMSWS

Small Angle Beam Transducers—European Standards

Type MWB/MWK

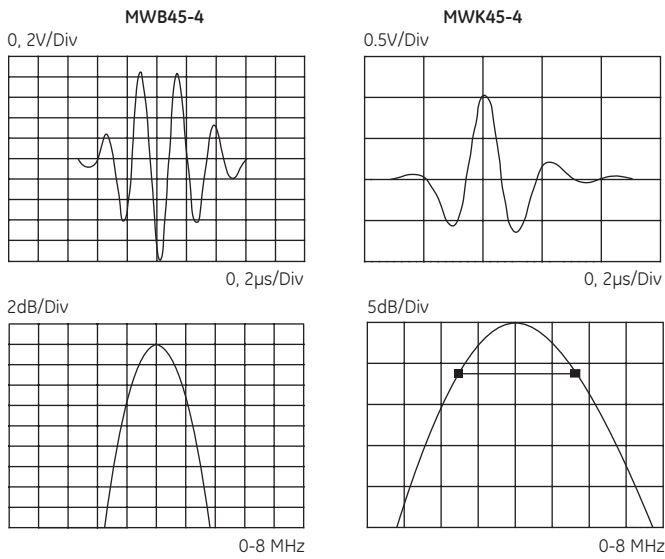

Typical waveform and frequency spectrum

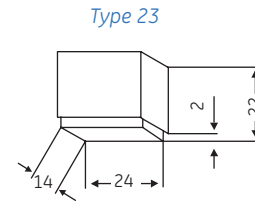

Type	Order Code	a x b		f (MHz)	β (Steel)	N		Notes	Sketch
		mm	in			mm	in		
MWB 35-2	56920	8 x 9	.31 x .35	2	38	15	0.6	DIN EN 12668-2 compliant Top connector DIN EN 12668-2 compliant	Type 23
MWB 35-2EN	500040	8 x 9	.31 x .35	2	38	15	0.6		
MWB 35-O2	57204	8 x 9	.31 x .35	2	38	15	0.6		
MWB 35-O2EN	500044	8 x 9	.31 x .35	2	38	15	0.6		
MWB 45-2	56921	8 x 9	.31 x .35	2	45	15	0.6	DIN EN 12668-2 compliant Top connector DIN EN 12668-2 compliant	
MWB 45-2EN	500041	8 x 9	.31 x .35	2	45	15	0.6		
MWB 45-O2	57205	8 x 9	.31 x .35	2	45	15	0.6		
MWB 45-O2EN	500045	8 x 9	.31 x .35	2	45	15	0.6		
MWB 60-2	56922	8 x 9	.31 x .35	2	60	15	0.6	DIN EN 12668-2 compliant Top connector DIN EN 12668-2 compliant	
MWB 60-2EN	500042	8 x 9	.31 x .35	2	60	15	0.6		
MWB 60-O2	57206	8 x 9	.31 x .35	2	60	15	0.6		
MWB 60-O2EN	500046	8 x 9	.31 x .35	2	60	15	0.6		
MWB 70-2	56923	8 x 9	.31 x .35	2	70	15	0.6	DIN EN 12668-2 compliant Top connector DIN EN 12668-2 compliant	
MWB 70-2EN	500043	8 x 9	.31 x .35	2	70	15	0.6		
MWB 70-O2	57207	8 x 9	.31 x .35	2	70	15	0.6		
MWB 70-O2EN	500234	8 x 9	.31 x .35	2	70	15	0.6		
MWB 80-2	56924	8 x 9	.31 x .35	2	77	15	0.6	Top connector Surface wave	
MWB 80-O2	57208	8 x 9	.31 x .35	2	77	15	0.6		
MWB 90-2	56925	8 x 9	.31 x .35	2	90	15	0.6		

Small Angle Beam Transducers—European Standards

Type	Order Code	a x b		f (MHz)	β (Steel)	N		Notes	Sketch	
		mm	in			mm	in			
MWB 35-4	56926	8 x 9	.31 x .35	4	38	30	1.2		Type 23	
MWB 35-4EN	500047	8 x 9	.31 x .35	4	38	30	1.2	DIN EN 12668-2 compliant		
MWB 35-04	57210	8 x 9	.31 x .35	4	38	30	1.2	Top connector		
MWB 35-04EN	500235	8 x 9	.31 x .35	4	38	30	1.2	DIN EN 12668-2 compliant		
MWB 45-4	56927	8 x 9	.31 x .35	4	45	30	1.2			
MWB 45-4EN	500048	8 x 9	.31 x .35	4	45	30	1.2	DIN EN 12668-2 compliant		
MWB 45-04	57211	8 x 9	.31 x .35	4	45	30	1.2	Top connector		
MWB 45-04EN	500236	8 x 9	.31 x .35	4	45	30	1.2	DIN EN 12668-2 compliant		
MWB 60-4	56928	8 x 9	.31 x .35	4	60	30	1.2			
MWB 60-4EN	500049	8 x 9	.31 x .35	4	60	30	1.2	DIN EN 12668-2 compliant		
MWB 60-04	57212	8 x 9	.31 x .35	4	60	30	1.2	Top connector		
MWB 60-04EN	500237	8 x 9	.31 x .35	4	60	30	1.2	DIN EN 12668-2 compliant		
MWB 70-4	56929	8 x 9	.31 x .35	4	70	30	1.2			
MWB 70-4EN	500050	8 x 9	.31 x .35	4	70	30	1.2	DIN EN 12668-2 compliant		
MWB 70-04	57213	8 x 9	.31 x .35	4	70	30	1.2	Top connector		
MWB 70-04EN	500238	8 x 9	.31 x .35	4	70	30	1.2	DIN EN 12668-2 compliant		
MWB 80-4	56930	8 x 9	.31 x .35	4	7	30	1.2			
MWB 80-04	57214	8 x 9	.31 x .35	4	77	30	1.2	Top connector		
MWB 90-4	56931	8 x 9	.31 x .35	4	90	30	1.2	Surface wave		
MWK 45-2	67488	8 x 9	.31 x .35	2	45	15	0.6	Piezocomposite element		Type 23
MWK 60-2	67489	8 x 9	.31 x .35	2	60	15	0.6			
MWK 70-2	67490	8 x 9	.31 x .35	2	70	15	0.6			
MWK 45-4	58938	8 x 9	.31 x .35	4	45	30	1.2			
MWK 60-4	58939	8 x 9	.31 x .35	4	60	30	1.2			
MWK 70-4	58940	8 x 9	.31 x .35	4	70	30	1.2			

Custom configurations are available by special order.

For explanations to the table data, refer to Selection Criteria on pages 2 through 4.

Accessories

Description	Type	Remark
Cable	MPKL2 (50486)	for MWB.., MWK..
Spare sole (1 set = 10 pcs)	MWP(E) (57277)	for MWB.., MWK..

Small Angle Beam Transducers—North American Standards

Type MSW-QC

Replaceable Wedge 6 mm (.25 in)											
Wedge Angle	A		B		C		D		E		Thread
	mm	in	mm	in	mm	in	mm	in	mm	in	
45°	11.4	.45	19.1	.75	9.4	.37	14.1	0.56	10.7	0.42	3/8 - 32
60°	11.4	.45	21.3	.84	11.2	.44	14.1	0.56	10.7	0.42	3/8 - 32
70°	11.4	.45	25.4	1.00	12.7	.50	14.1	0.56	10.7	0.42	3/8 - 32
90°	11.4	.45	24.1	.95	12.7	.50	14.1	0.56	10.7	0.42	3/8 - 32

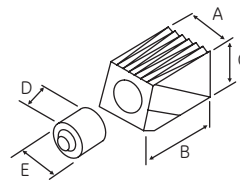

Replaceable Wedge 10 mm (.375 in)											
Wedge Angle	A		B		C		D		E		Thread
	mm	in	mm	in	mm	in	mm	in	mm	in	
45°	14.0	.55	22.6	.89	11.9	.47	14.7	0.58	14.0	0.55	1/2 - 28
60°	14.0	.55	26.4	1.04	14.0	.55	14.7	0.58	14.0	0.55	1/2 - 28
70°	14.0	.55	30.2	1.19	14.7	.58	14.7	0.58	14.0	0.55	1/2 - 28
90°	14.0	.55	29.2	1.15	15.5	.61	14.7	0.58	14.0	0.55	1/2 - 28

Replaceable Wedge 13 mm (.50 in)											
Wedge Angle	A		B		C		D		E		Thread
	mm	in	mm	in	mm	in	mm	in	mm	in	
45°	17.8	.70	26.7	1.05	14.0	.55	16.5	0.65	17.8	0.70	5/8 - 24
60°	17.8	.70	31.5	1.24	16.3	.64	16.5	0.65	17.8	0.70	5/8 - 24
70°	17.8	.70	35.8	1.41	17.3	.68	16.5	0.65	17.8	0.70	5/8 - 24
90°	17.8	.70	35.3	1.39	18.5	.73	16.5	0.65	17.8	0.70	5/8 - 24

Miniature Angle Beam Transducers—Type MSW-QC (Quick Change)

Freq. (MHz)	Element Ø mm	Element Ø in	Order Codes					Accessories	Freq. (MHz)	Element Ø mm	Element Ø in	Order Code					Accessories															
			Gamma Series	Benchmark Series	Alpha Series	Standard Wedge (W = 118-340)						Gamma Series	Benchmark Series	Alpha Series	Standard Wedge (W = 118-340)																	
1.0	13	.500	241-590	241-591		W-210 30° W-211 45° W-212 60° W-213 70° W-214 90°		6	.250		224-590	224-591	124-591		W-200 30° W-201 45° W-202 60° W-203 70° W-204 90°																	
																	1.5	10	.375	231-590	231-596		W-220 30° W-221 45° W-222 60° W-223 70° W-224 90°		5.0	10	.375	234-590	234-591	134-591		W-220 30° W-221 45° W-222 60° W-223 70° W-224 90°
2.25	6	.250	222-590	222-591	122-591		W-200 30° W-201 45° W-202 60° W-203 70° W-204 90°	Cables BNC 118-140-012	6	.250		225-591	125-591		W-200 30° W-201 45° W-202 60° W-203 70° W-204 90°	Cables BNC 118-140-012																
																	10	.375	232-590	232-591	132-591		W-220 30° W-221 45° W-222 60° W-223 70° W-224 90°	LEMO-1 118-140-022	7.5	10	.375		235-591	135-591		W-220 30° W-221 45° W-222 60° W-223 70° W-224 90°
13	.500	242-590	242-591	142-591		W-210 30° W-211 45° W-212 60° W-213 70° W-214 90°	Wedge Couplant 118-300-740	13	.500		245-591	145-591		W-210 30° W-211 45° W-212 60° W-213 70° W-214 90°	Wedge Couplant 118-300-740																	
																3.5	6	.250	223-590	223-591	123-591		W-200 30° W-201 45° W-202 60° W-203 70° W-204 90°		6	.250	226-590		W-200 30° W-201 45° W-202 60° W-203 70° W-204 90°			
10	.375	233-590	233-591	133-591		W-220 30° W-221 45° W-222 60° W-223 70° W-224 90°		10	10	.375	236-590		W-220 30° W-221 45° W-222 60° W-223 70° W-224 90°																			
															13	.500	243-590	243-591	143-591		W-210 30° W-211 45° W-212 60° W-213 70° W-214 90°		13	.500	246-590		W-210 30° W-211 45° W-212 60° W-213 70° W-214 90°					

Note: Standard wedge angles are specified for carbon steel. Custom configurations are available by special order.

Small Angle Beam Transducers—North American Standards

Type MSWS

Replaceable Wedge .25 in (6 mm)												
Wedge Angle	A		B		C		D		E		F	
	mm	in	mm	in	mm	in	mm	in	mm	in	mm	in
45°	11.9	.47	15.2	.60	7.6	.30	7.9	.31	12.2	.48	8.6	.34
60°	11.9	.47	16.5	.65	8.9	.35	7.9	.31	12.2	.48	8.6	.34
70°	11.9	.47	17.8	.70	9.7	.38	7.9	.31	12.2	.48	8.6	.34
90°	11.9	.47	22.9	.90	9.7	.38	7.9	.31	12.2	.48	8.6	.34

Replaceable Wedge .50 in (13 mm)												
Wedge Angle	A		B		C		D		E		F	
	mm	in	mm	in	mm	in	mm	in	mm	in	mm	in
45°	18.5	.73	24.4	.96	10.7	.42	14.2	.56	18.5	.73	12.7	.50
60°	18.5	.73	27.4	1.08	12.7	.50	14.2	.56	18.5	.73	12.7	.50
70°	18.5	.73	29.5	1.16	13.7	.54	14.2	.56	18.5	.73	12.7	.50
90°	18.5	.73	39.6	1.56	14.7	.58	14.2	.56	18.5	.73	12.7	.50

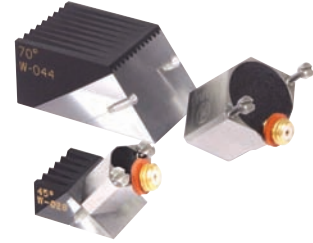
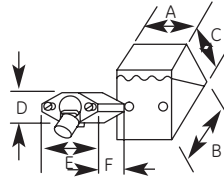

Miniature Angle Beam Transducers—Type MSWS (Captive Screw Mount)

Freq. (MHz)	Element Ø		Order Codes			Freq. (MHz)	Element Ø		Order Codes		
	mm	in	Gamma Series	Standard Wedge (W = 118-340)	Accessories		mm	in	Gamma Series	Standard Wedge (W = 118-340)	Accessories
1.0	13	.500	241-580	W-040 45° W-042 60° W-044 70° W-046 80° W-048 90°		5.0	6	.250	224-580	W-028 45° W-030 60° W-032 70° W-034 80° W-036 90°	
2.25	6	.250	222-580	W-028 45° W-030 60° W-032 70° W-034 80° W-036 90°	Cables BNC 118-140-012	10.0	13	.500	244-580	W-040 45° W-042 60° W-044 70° W-046 80° W-048 90°	Cables BNC 118-140-012 LEMO-1 118-140-022
3.5	13	.500	242-580	W-040 45° W-042 60° W-044 70° W-046 80° W-048 90°	LEMO-1 118-140-022 Wedge Couplant 118-300-740	10.0	6	.250	226-580	W-028 45° W-030 60° W-032 70° W-034 80° W-036 90°	Wedge Couplant 118-300-740
3.5	6	.250	223-580	W-028 45° W-030 60° W-032 70° W-034 80° W-036 90°		10.0	13	.500	246-580	W-040 45° W-042 60° W-044 70° W-046 80° W-048 90°	
3.5	13	.500	243-580	W-040 45° W-042 60° W-044 70° W-046 80° W-048 90°		10.0	6	.250	243-580	W-040 45° W-042 60° W-044 70° W-046 80° W-048 90°	

Note: Standard wedge angles are specified for carbon steel. Custom configurations are available by special order.

Small Angle Beam Transducers—North American Standards

Angle	A		B		C		D		E		F	
	mm	in	mm	in	mm	in	mm	in	mm	in	mm	in
45°	7.9	.31	6.4	.25	5.3	.21	4.8	.19	5.8	.23	7.1	.28
60°	7.9	.31	10.7	.42	5.3	.21	4.8	.19	5.8	.23	7.1	.28
70°	7.9	.31	10.7	.42	5.3	.21	4.8	.19	5.8	.23	7.1	.28
90°	7.9	.31	18.3	.72	8.6	.34	4.8	.19	5.8	.23	7.1	.28

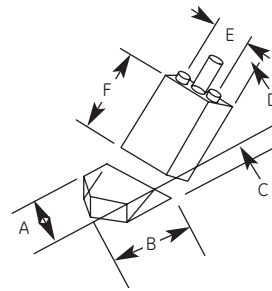

Subminiature Angle Beam Type SMSWS (Screw Mount)

Freq. (MHz)	Element Ø		Gamma Series	Order Codes	
	mm	in		Standard Wedge (W = 118-340)	Accessories
2.25	3	.125	212-585	W-120 45°	Cable BNC 118-140-047 Wedge Couplant 118-300-740
				W-121 60°	
				W-122 70°	
				W-123 90°	
5.0	3	.125	214-585	W-120 45°	
				W-121 60°	
				W-122 70°	
				W-123 90°	
10.0	3	.125	216-585	W-120 45°	
				W-121 60°	
				W-122 70°	
				W-123 90°	

Note: Standard wedge angles are specified for carbon steel. Custom configurations are available by special order.

Angle Beam Transducers, Dual Element (TR)



Applications

- VS shear wave type
 - Detection of small, near surface flaws
 - Thin-walled tubes and containers
 - Rings
- VRY and VSY longitudinal wave types
 - Coarse grain weld inspection
 - Attenuative materials
 - Austenitic welds
 - "Creeping wave" applications with 70° models

Features and Benefits

- Excellent near surface resolution
- Reduce noise caused by scattering
- Durable, ergonomically-designed die cast housing
- Types VS and VSY have side mounted Microdot connectors
- Type VRY has Lemo 00 connectors

Angle Beam Transducers, Dual Element (TR)

Types VS, VRY and VSY

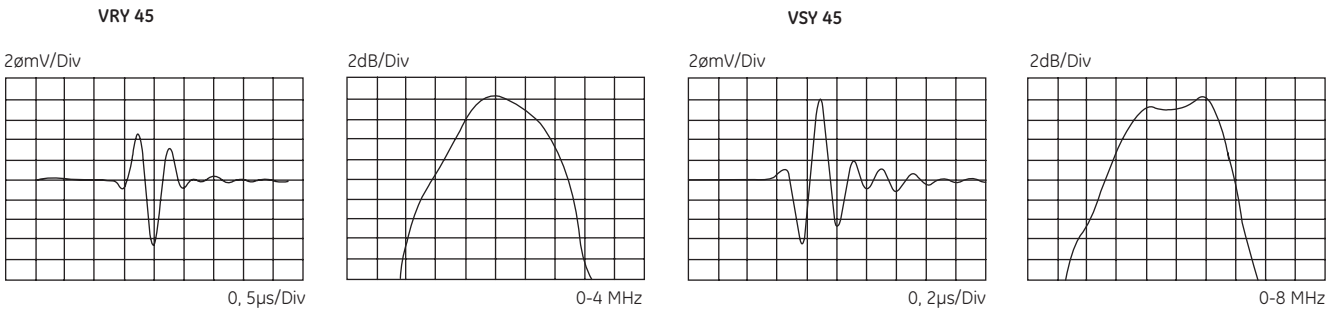

Typical waveform and frequency spectrum

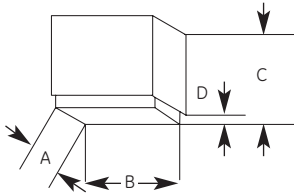

Case Type	A		B		C		D	
	mm	in	mm	in	mm	in	mm	in
Type 30	14	0.55	24	0.94	22	0.87	2	0.08
Type 31	29	1.14	53.5	2.1	45	1.77	5	0.20
Type 32	15	0.59	30	1.8	27	1.06		

Type	Order Code	a x b		f (MHz)	β (Steel)	F		Notes	Sketch
		mm	in			mm	in		
VS 45	57660	3.5 x 10	.14 x .39	4	45	10	0.4	DIN EN 12668-2 compliant	Type 30
VS 45-EN	500194	3.5 x 10	.14 x .39	4	45	10	0.4		
VS 60	57661	3.5 x 10	.14 x .39	4	60	10	0.4		
VS 60-EN	500195	3.5 x 10	.14 x .39	4	60	10	0.4		
VS 70	57662	3.5 x 10	.14 x .39	4	70	10	0.4		
VS 70-EN	500196	3.5 x 10	.14 x .39	4	70	10	0.4	DIN EN 12668-2 compliant	
VRY 45	57663	10 x 22	.39 x .87	1.8	45	40	1.6	VRY and VSY angles are longitudinal (compression) wave suitable for testing coarse grain materials.	Type 31
VRY 60	57664	10 x 22	.39 x .87	1.8	60	35	1.4		
VRY 70	57665	10 x 22	.39 x .87	1.8	70	35	1.4		
VSY 45-2	67154	5 x 10	.20 x .39	2	45	16	0.6	70° models suitable for creeping wave excitation in mild steel.	Type 32
VSY 60-2	67155	5 x 10	.20 x .40	2	60	16	0.6		
VSY 70-2	67156	5 x 10	.20 x .41	2	70	16	0.6		
VSY 45-4	54577	5 x 10	.20 x .42	4	45	20	0.8		
VSY 60-4	54578	5 x 10	.20 x .43	4	60	20	0.8		
VSY 70-4	54579	5 x 10	.20 x .44	4	70	20	0.8		

Custom configurations are available by special order.

For explanations to the table data, refer to Selection Criteria on pages 2 through 4.

Accessories Description	Type	Remark
Cable	SEKM2 (53001)	for VS
	SEKL2 (50710)	for VRY
	SEKN2 (53775)	for VSY

Immersion Transducers



Applications

- Parts with irregular or complex geometry, such as gears and valves
- Automated or mechanized scanning
- Applications requiring very high near surface resolution or detection of very small flaws
- Scanning pipes, tubes and tanks
- Plates, billets and bars
- Disks, axles and shafts

Features and Benefits

- Acoustically matched for best efficiency in water
- Can be focused to a point (spherical) or to a line (cylindrical) for improved resolution, sensitivity and signal-to-noise ratio (refer to Selection Criteria on pages 2 through 4)
- European models have fixed cable with LEMO-1 connector.
- North American models have waterproof UHF connector, except IPS type, which has non-waterproof Microdot.

Minimum and Maximum Standard Focal Lengths (Longer or Shorter Focal Lengths May Be Available By Special Order)

		Element Diameter: mm (in)															
Frequency (MHz)		25.4 (1.0)	20.0 (0.79)	19.1 (0.75)	12.7 (0.5)	10.0 (0.39)	9.5 (0.375)	6.4 (0.25)	5.0 (0.2)								
1.0	N	109 (4.3)	67 (2.7)	61 (2.4)	28 (1.1)												
	Min	50 (2)	40 (1.5)	40 (1.5)	25 (1)												
	Max	75 (3)	50 (2)	50 (2)	25 (1)												
2.0	N		135 (5.3)			34 (1.3)											
	Min		40 (1.5)			20 (0.8)											
	Max		100 (4)			25 (1)											
2.25	N	245 (9.6)		138 (5.4)	61 (2.4)		34 (1.4)	16 (0.6)									
	Min	50 (2)		40 (1.5)	25 (1)		20 (0.8)	13 (0.5)									
	Max	150 (6)		100 (4)	50 (2)		25 (1)	13 (0.5)									
3.5	N	381 (15)		215 (8.4)	94 (3.7)		53 (2.1)	24 (0.9)									
	Min	50 (2)		40 (1.5)	25 (1)		20 (0.8)	13 (0.5)									
	Max	200 (8)		150 (6)	60 (2.5)		40 (1.5)	17 (0.7)									
4.0	N		270 (10.7)			67 (2.6)											
	Min		40 (1.5)			20 (0.8)											
	Max		200 (8)			50 (2)											
5.0	N	544 (21.4)	337 (13.4)	307 (12.0)	137 (5.4)	84 (3.3)	76 (3.0)	35 (1.3)	21 (0.9)								
	Min	50 (2)	40 (1.5)	40 (1.5)	25 (1)	20 (0.8)	20 (0.8)	13 (0.5)	10 (0.4)								
	Max	200 (8)	200 (8)	200 (8)	100 (4)	60 (2.4)	50 (2)	25 (1.0)	15 (0.6)								
10.0	N			615 (24.1)	272 (10.7)		152 (6.0)	69 (2.7)	42 (1.7)								
	Min			40 (1.5)	25 (1)		20 (0.8)	13 (0.5)	10 (0.4)								
	Max			200 (8)	150 (6)		100 (4)	50 (2)	30 (1.2)								
15.0	N				406 (16)		228 (9.0)	104 (4.0)									
	Min				25 (1)		20 (0.8)	13 (0.5)									
	Max				150 (6)		150 (6)	60 (2.5)									

Notes:

N = Near field length in water

Min = Minimum recommended focal length in water

Max = Maximum recommended focal length in water

Distances in steel are approximately 1/4 the distances given for water. Longer or shorter focal lengths may be available by special order.

Immersion Transducers—European Standards

Types Z, H and L



Z..N, H..N and L..N



Z..K, H..K and L..K



Z..M, H..M and L..M

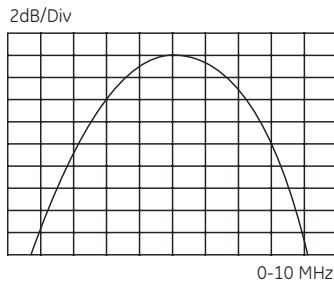
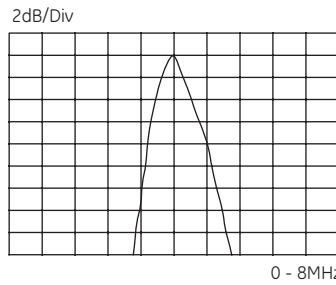
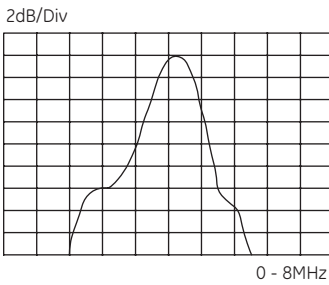
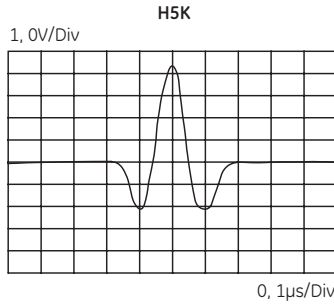
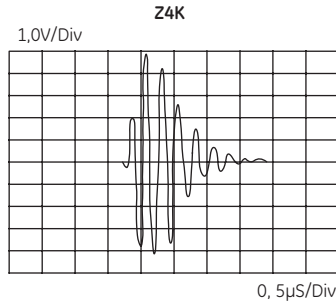
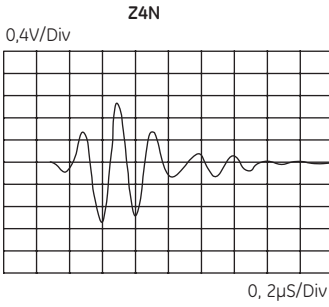

Typical waveform and frequency spectrum

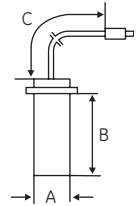

Type	Order Code	D	f	N	Notes	Sketch		
		mm	in	(MHz)	mm	in		
Z 1 N	53317	20	0.79	1	64	2.5	Type 33	
Z 2 N	53318	20	0.79	2	127	5.0		
Z 4 N	53319	20	0.79	4	254	10.0		
Z 5 N	54705	20	0.79	5	318	12.5		
Z 2 K	53341	10	0.39	2	32	1.3		High sensitivity (gain reserve) for testing small to mid-size objects. Type 34
Z 4 K	53342	10	0.39	4	64	2.5		
Z 5 K	53732	10	0.39	5	80	3.1		
Z 10 K	54704	10	0.39	10	160	6.3		
Z 5 M	55468	5	0.20	5	20	0.8	Type 35	
Z 10 M	53367	5	0.20	10	40	1.6		
Z 15 M	55576	5	0.20	15	60	2.4		
H 1 N	53042	20	0.79	1	64	2.5	Shock wave transducers especially suitable for thickness measurement or other applications requiring high resolution. Type 33	
H 2 N	53043	20	0.79	2	127	5.0		
H 2 K	53300	10	0.39	2	32	1.3		
H 5 K	53032	10	0.39	5	80	3.1		
H 10 K	55818	10	0.39	10	160	6.3		
H 5 M	53258	5	0.20	5	20	0.8		
H 10 M	53041	5	0.20	10	40	1.6		
L 1 N	53133	20	0.79	1	63	2.5		Broadband for applications requiring high resolution. Type 33
L 2 N	53134	20	0.79	2	127	5.0		
L 2 K	53137	10	0.39	2	32	1.3		
L 5 K	53139	10	0.39	5	80	3.1		
L 5 M	53143	5	0.20	5	20	0.8		

Case Type	A		B		C	
	mm	in	mm	in	m	feet
Type 33	24	0.94	60	2.36	2.5	8.2
Type 34	13	0.51	60	2.36	2.5	8.2
Type 35	9.5	0.37	25	0.98	1.5	3.9

Also available with spherical (point) and cylindrical (line) focusing. Specify focal length. For available focal lengths, refer to the table at beginning of the Immersion Transducers section.

Custom configurations are available by special order.

For explanations to the table data, refer to Selection Criteria on pages 2 through 4.

Immersion Transducers—North American Standards

Types ISS and IS

Element Ø		A		B	
mm	in	mm	in	mm	in
6	.25	16	0.63	39.4	1.55
10	.375	16	0.63	39.4	1.55
13	.50	16	0.63	39.4	1.55
19	.75	25.4	1.00	45.0	1.77
25	1.0	31.8	1.25	46.2	1.82

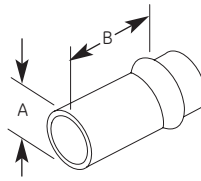

Immersion Transducers—Types ISS and IS

Freq. (MHz)	Element Ø		Order Code				Freq. (MHz)	Element Ø		Order Code			
			*Focus	Alpha Series	Gamma Series	Benchmark Series				*Focus	Alpha Series	Gamma Series	Benchmark Series
1.0	19	.750	S		251-360		6	.250	S	124-280	224-280		
			C		251-370				C	124-290	224-290		
			N		251-380				N	124-300	224-300	824-300	
2.25	10	.375	S		261-360	861-360	10.0	10	.375	S	134-280	234-280	834-280
			C		261-370	861-370				C	134-290	234-290	834-290
			N		261-380	861-380				N	134-300	234-300	834-300
3.5	6	.250	S		222-280		5.0	13	.500	S	144-280	244-280	844-280
			C		222-290					C	144-290	244-290	844-290
			N	122-300	222-300	822-300				N	144-300	244-300	844-300
10.0	10	.375	S	132-280	232-280		10.0	19	.750	S	154-360	254-360	854-360
			C	132-290	232-290					C	154-370	254-370	854-370
			N	132-300	232-300	832-300				N	154-380	254-380	854-380
15.0	13	.500	S	142-280	242-280	842-280	15.0	25	1.00	S	164-360	264-360	864-360
			C	142-290	242-290	842-290				C	164-370	264-370	864-370
			N	142-300	242-300	842-300				N	164-380	264-380	864-380
15.0	19	.750	S	152-360	252-360	852-360	15.0	6	.250	S	126-280	226-280	
			C	152-370	252-370	852-370				C	126-290	226-290	
			N	152-380	252-380	852-380				N	126-300	226-300	
15.0	25	1.00	S	162-360	262-360	862-360	15.0	10	.375	S	136-280	236-280	
			C	162-370	262-370	862-370				C	136-290	236-290	
			N	162-380	262-380	862-380				N	136-300	236-300	
15.0	13	.500	S	143-280	243-280	843-280	15.0	13	.500	S	146-280	246-280	
			C	143-290	243-290	843-290				C	146-290	246-290	
			N	143-300	243-300	843-300				N	146-300	246-300	
15.0	19	.750	S	153-360	253-360	853-360	15.0	19	.750	S	156-360	256-360	
			C	153-370	253-370	853-370				C	156-370	256-370	
			N	153-380	253-380	853-380				N	156-380	256-380	
15.0	25	1.00	S	163-360	263-360	863-360	15.0	6	.250	S	127-280		
			C	163-370	263-370	863-370				C	127-290		
			N	163-380	263-380	863-380				N	127-300		
15.0	6	.250	S				15.0	6	.250	1.5 in S	127-302 (TTC-100)		
			C							C	137-280		
			N							N	137-290		
15.0	10	.375	S				15.0	10	.375	S	147-280		
			C							C	147-290		
			N							N	147-300		

Note: Waterproof cables are in the Accessories Section.

* Focus: S = Spherical, C = Cylindrical, N = Non-focus. Focal length must be specified. For available focal lengths, refer to the table at the beginning of the Immersion Transducers section. Custom configurations are available by special order.

Immersion Transducers—North American Standards

Type IPS

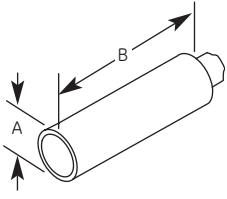

Element Ø		A		B	
mm	in	mm	in	mm	in
6	.250	9.7	0.38	36.8	1.45



Immersion Transducers—Type IPS

Freq. (MHz)	Element Ø		Order Code				Freq. (MHz)	Element Ø		Order Code			
	mm	in	*Focus	Alpha Series	Gamma Series	Accessories		mm	in	*Focus	Alpha Series	Gamma Series	Accessories
2.25	6	0.25	N	122-340	222-340	Cable BNC 118-140-012 Non-waterproof	10.0	6	0.25	S	126-320	226-320	Cable BNC 118-140-012 Non-waterproof
										C	126-330	226-330	
										N	126-340	226-340	
5.0	6	0.25	S	124-320	224-320	15.0	6	0.25	S	127-320		118-140-012 Non-waterproof	
			C	124-330	224-330				C	127-330			
			N	124-340	224-340				N	127-340			

* Focus: S = Spherical, C = Cylindrical, N = Non-focus. Focal length must be specified. For available focal lengths, refer to the table at the beginning of the Immersion Transducers section. Custom configurations are available by special order.

Type IR

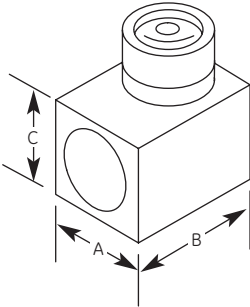

Element Ø		A		B		C	
mm	in	mm	in	mm	in	mm	in
6	.250	19.1	0.75	23.9	0.94	19.1	0.75
10	.375	19.1	0.75	23.9	0.94	19.1	0.75
13	.500	19.1	0.75	23.9	0.94	19.1	0.75



Immersion Transducers—Type IR

Freq. (MHz)	Element Ø		Order Code			Freq. (MHz)	Element Ø		Order Code		
	mm	in	*Focus	Alpha Series	Gamma Series		mm	in	*Focus	Alpha Series	Gamma Series
2.25	6	0.25	N	122-420	222-420	5.0	6	0.25	S	124-400	224-400
									C	124-410	224-410
									N	124-420	224-420
	10	0.375	S	132-400	232-400						
			C	132-410	232-410						
			N	132-420	232-420						
	13	0.50	S	142-400	242-400						
			C	142-410	242-410						
			N	142-420	242-420						
		S	134-400	234-400							
		C	134-410	234-410							
		N	134-420	234-420							
		S	144-400	244-400							
		C	144-410	244-410							
		N	144-420	244-420							

* Focus: S = Spherical, C = Cylindrical, N = Non-focus. Focal length must be specified. For available focal lengths, refer to the table at the beginning of the Immersion Transducers section. Waterproof cables can be found in the Transducers Accessories Section. Custom configurations are available by special order.

Transducers for Specific Applications

GE Inspection Technologies' Application Centers provide a broad spectrum of services to users of nondestructive testing applications. Our mission is to bring together worldwide knowledge and experience across multiple industries and modalities to help customers quickly solve their inspection application problems.

With an unsurpassed track record, our highly skilled engineers, technicians and specialists are a key asset for our customers. Their experience is broad, encompassing many NDT modalities and many industry segments—from the development of a radiographic solution to inspect aerospace parts on the manufacturing floor to the design of customized ultrasound transducers or eddy current probes for field inspection in the power, oil, gas and automotive industries.

New materials, manufacturing processes, and joining technologies often require customized ultrasonic transducers and accessories, designed specifically for the particular application. We offer a wide range of special application transducers, some of which are shown on these pages. Our special transducer teams are ready to address new application problems quickly and effectively. For more information and an inquiry form, visit GE Inspection Technologies on the Internet at www.ge.com/inspectiontechnologies.

Special Application Transducers

Roller (Wheel) Transducers

Ultrasonic roller transducers and systems for the inspection of overlapped and butt laser welds or brazed joints and welds on tailored blanks with dry coupling.



Low Frequency Transducers

Ultrasonic transducers for the inspection of coarse materials such as concrete, refractory bricks, stones, and wood.



Axle Transducers

Ultrasonic transducers for the inspection of railway axles and wheel sets.

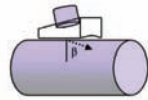

Transducer Holders

Ultrasonic transducer holders for special fixtures for the inspection of gas bottles and tubes.



Transverse (Shear) Wave Straight Beam Transducers

Normal incidence transverse wave transducers typically used for characterization of materials.



Spot Weld Transducers

Ultrasonic transducers with a flexible acoustic interface for inspection of resistance welded spot welds on automotive bodies.



MIG/MAG Transducers

Ultrasonic transducers for the inspection of MIG and MAG welds using the ultrasonic transmission technique.



Tube Testing Transducers

Ultrasonic transducers for the inspection of tubes and hollow railway axles and wheel sets.



High Temperature Transducers

Ultrasonic transducers for inspection at higher temperatures with heat resistant delays.



High Frequency Immersion Transducers

Very high resolution immersion transducers, 25 MHz to 50 MHz.



RL Transducers

Refracted longitudinal wave angle beam transducers, single and dual element, for inspection of coarse grain materials such as austenitic steel pipe welds.



Boreside Arrays

Multi-element ultrasonic transducers, with water feed, for the inspection of tubing from the ID.



ZIP Probes

"Zero Interface" delay line transducers for manual inspection of composite materials.



Phased Array Transducers

GE Inspection Technologies manufactures a wide variety of phased array transducers for use with Phasor and other instruments. Phasor transducers with the Dialog feature recognize physical connection and automatically download transducer information to Phasor. More information on our full range of phased array transducers is available at www.ge.com/inspectiontechnologies.

Small and Mid-Sized Phased Arrays for General Angle and Straight Beam Applications

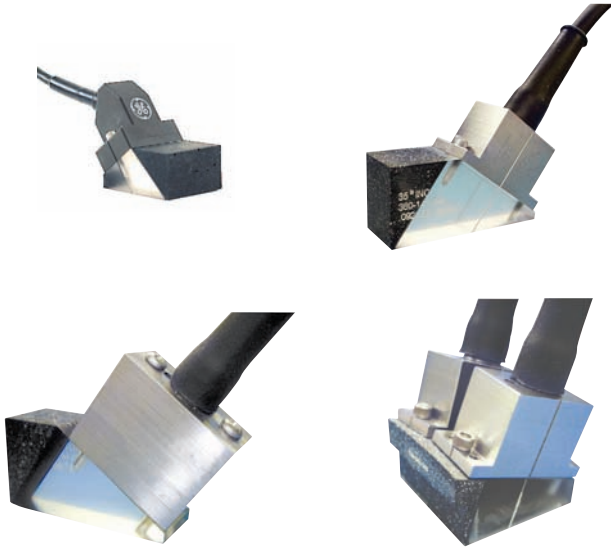

Applications

- Power: General weld inspection, austenitic welds, pressure vessels and piping, turbine blades, rotors
- Oil and Gas: Pipeline girth welds, tanks, general weld inspection
- Aerospace: Weld inspection, landing gear
- Automotive: Axles, shafts, spindles, brake discs, wheels
- General: Welds, forgings, castings, tubular goods, bridges and structures

Features and Benefits

- Electronic control of beam angle, focus, and scanning index
- Eliminate multiple inspections with fixed angle and fixed focus probes.
- Inspect hard to access areas from a single contact point.
- Replaceable angle beam wedges and 0° delay lines, flat or curved
- Probes with internal wedges and delay lines are also available.

Typical Specifications (Others Available Upon Request)

Frequency (MHz)	Element Count	Pitch mm (in)	Elevation mm (in)
1.0	16, 32, 64, 128	1 to 3 (.04 to .12)	10 to 25 (0.4 to 1.0)
1.5	16, 32, 64, 128	0.75 to 3 (.03 to .12)	10 to 25 (0.4 to 1.0)
2.25	16, 32, 64, 128	0.5 to 2 (.02 to .08)	6 to 20 (0.25 to 0.8)
3.5	16, 32, 64, 128	0.5 to 2 (.02 to .08)	6 to 20 (0.25 to 0.8)
5.0	16, 32, 64, 128	0.25 to 1.5 (.01 to .06)	6 to 20 (0.25 to 0.8)
7.5	16, 32, 64, 128	0.25 to 1 (.01 to .04)	6 to 16 (0.25 to 0.63)

Phased Array for Scanning and Wide Area Coverage, Immersion or Delay Line



Applications

- Power Generation: Pressure vessels, piping
- Oil and Gas: Piping, tanks
- Aerospace: Composite delamination and disbond, weld inspection, landing gear
- Transportation: Composite delamination and disbond, plates
- General: Large area scanning, plate, bar, tubular goods, in-line thickness measurement

Features and Benefits

- Electronic control of beam angle, focus, and scanning index
- Reduce set-up and scan times.
- Increase sensitivity and signal-to-noise ratio with electronic focusing.
- Reduce or eliminate mechanical and manual manipulation.
- Use immersion method or with replaceable delay line.

Typical Specifications (Others Available Upon Request)

Frequency (MHz)	Element Count	Pitch/mm (in)	Elevation/mm (in)
1.0	32, 64, 128	1 to 3 (.04 to .12)	10 to 25 (0.4 to 1.0)
1.5	32, 64, 128	0.75 to 3 (.03 to .12)	10 to 25 (0.4 to 1.0)
2.25	32, 64, 128	0.5 to 2 (.02 to .08)	6 to 20 (0.25 to 0.8)
3.5	32, 64, 128	0.5 to 2 (.02 to .08)	6 to 20 (0.25 to 0.8)
5.0	32, 64, 128	0.25 to 1.5 (.01 to .06)	6 to 20 (0.25 to 0.8)
7.5	32, 64, 128	0.25 to 1 (.01 to .04)	6 to 16 (0.25 to 0.63)
10.0	32, 64, 128	0.25 to 1 (.01 to .04)	6 to 13 (0.25 to 0.5)

Transducer Accessories

Cables and Adapters

Plug Type

Cable Type	Order Code	Length m (ft)	Impedance (ohms)	Transducer	Instrument
CL 331	58160	2 (6.5)	50	Microdot	LEMO-00
MPKLL 2	58791	2 (6.5)	50	LEMO-00	LEMO-00
MPKL 2	50486	2 (6.5)	50	LEMO-00	LEMO-1
MPKM 2	52999	2 (6.5)	50	Microdot	LEMO-1
PKP 2	66709	2 (6.5)	75	LEMO-03 Waterproof	LEMO-1
PKI 2	57694	2 (6.5)	75	UHF Waterproof	LEMO-1
PKLL 2	50326	2 (6.5)	75	LEMO-1	LEMO-1
PKTL 2	52642	2 (6.5)	50	LEMO-1 Waterproof	LEMO-1
SEKG 2	53887	2 (6.5)	50	LEMO-00 Dual Plug	2x LEMO-1
SEKL 2	50710	2 (6.5)	50	2x LEMO-00	2x LEMO-1
SEKM 2	53001	2 (6.5)	50	2x Microdot	2x LEMO-1
SEKN 2	53775	2 (6.5)	50	1x Microdot 1x Microdot, Large	2x LEMO-1
VKLL 5	50484	5 (16.4)	75	LEMO-1 Coupling	LEMO-1
MD-BNC	118-140-012	1.8 (6)	50	Microdot	BNC
MD-BNC 12	118-140-011	3.6 (12)	50	Microdot	BNC
MMD-BNC	118-140-047	1.8 (6)	50	MMD	BNC
MD/RA-BNC	118-140-033	1.8 (6)	50	Right Angle Microdot	BNC
BNC-BNC	118-140-016	1.8 (6)	50	BNC	BNC
BNC-BNC 12	118-140-021	3.6 (12)	50	BNC	BNC
UHF-BNC	118-140-027	1.8 (6)	50	UHF Non-waterproof	BNC
L1-BNC	118-140-018	1.8 (6)	50	LEMO-1	BNC
UHF/WP-BNC	118-140-013	1.8 (6)	75	UHF Waterproof	BNC
Dual MMD-BNC	118-140-014	1.8 (6)	50	2x MMD	2x BNC
Dual MD-BNC	118-140-024	1.8 (6)	50	2x Microdot	2x BNC



Plug Type

Adaptor Type	Order Code	Transducer	Instrument
PKLB1	53013	BNC Socket	LEMO-1 Plug
PKBL1	53014	LEMO-1 Socket	BNC Plug
STUHF-RA (Right Angle)	118-560-032	UHF Plug Waterproof	UHF Socket Waterproof
DM-BNC (Dual)	118-560-045	D-Meter Plug	2x BNC

Couplants

General Purpose Couplants

Couplant Type	Container Size	Description	Order Code	Features
ZG-F	2.5 kg(5.5 lb)	General Purpose	50469	<ul style="list-style-type: none"> • Thixotropic paste • Non-drip, washable, non-corrosive • Temperature range -4°F to 212°F (-20°C to 100°C) • Safety data sheet per 91/155/EEC
	5 bottles 250 ml (8.5 fl oz.)	General Purpose	54558	
ZGT	100 g Tube (3.5 oz.)	Multigrade Couplant	50472	<ul style="list-style-type: none"> • Medium viscosity paste • Water resistant, non-corrosive • Temperature range -22°F to 480°F (-30°C to 250°C) • Safety data sheet per 91/155/EEC
Exosen 20	3.8 liter (1 gal)	General Purpose, Medium Viscosity	118-300-420	<ul style="list-style-type: none"> • Water soluble • Non-toxic • Non-flammable • Non-irritating • Rust preventative added • Temperature range 32°F to 212°F (0°C to 100°C) • Material Safety Data Sheet per 29 CFR 1910.1200
	Case of 4 3.8 liter (1 gal)		118-300-425	
	18.9 liter (5 gal)		118-300-440	
	208 liter (55 gal)		118-300-460	
Exosen 30	3.8 liter (1 gal)	General Purpose, High Viscosity, Pourable	118-300-520	<ul style="list-style-type: none"> • Rust preventative added • Temperature range 32°F to 212°F (0°C to 100°C) • Material Safety Data Sheet per 29 CFR 1910.1200
	Case of 4 3.8 liter (1 gal)		118-300-525	
	18.9 liter (5 gal)		118-300-540	
	208 liter (55 gal)		118-300-560	

Specialty Couplants

Couplant Type	Container Size	Description	Order Code	Notes
ZGM	100 g Tube (3.5 oz.)	High Temperature Coupling Paste	56567	<ul style="list-style-type: none"> • High viscosity paste • Solid filler melts at elevated temperature • Specially formulated for thickness measurement on hot parts • Temperature range 390°F to 1100°F (200°C to 600°C)
Hitempco	79 g Tube (2.8 oz.)	High Temperature Coupling Grease	118-300-010	<ul style="list-style-type: none"> • High viscosity grease • Thickness measurement and flaw detection on hot parts • Temperature range 50°F to 550°F (10°C to 290°C) • Material Safety Data Sheet per 29 CFR 1910.1200
	12 Tubes 79 g (2.8 oz.)		118-300-015	
SLC	113 g (4 oz.)	High Viscosity, High Attenuation	118-300-080	<ul style="list-style-type: none"> • Extremely high viscosity • Allows transmission of transverse (shear) waves • High attenuation reduces noise on rough or curved surface • Material Safety Data Sheet per 29 CFR 1910.1200
XD-740	59 ml (2 fl oz.)	Wedge, Delay Line, Protective Face Couplant	118-300-740	<ul style="list-style-type: none"> • Applied between transducer face and accessory • Material Safety Data Sheet per 29 CFR 1910.1200
XL	236 ml (8 fl oz.)	Low Viscosity Laboratory Couplant	118-300-820	<ul style="list-style-type: none"> • For smooth surface, 1.6 µm (62 µin) RMS or better • Suitable for performance testing of ultrasonic transducers • Material Safety Data Sheet per 29 CFR 1910.1200
	3.78 liter (1 gal)		118-300-860	

Calibration Blocks

Calibration blocks provide known targets that produce echo indications that are used for instrument setup, transducer evaluation, and reference for evaluating flaw size.

Calibration Blocks—European Standards

Block Type (Steel)	Order Code	Description
K1 EN 12223	59108	<ul style="list-style-type: none"> Large angle beam calibration block, 100 mm radius Calibrate range with an angle beam transducer Measure beam index point and refracted angle
K2 EN 27963/ISO 7963	50434	<ul style="list-style-type: none"> Small angle beam calibration block, 25 and 50 mm radii Calibrate range with an angle beam transducer Measure beam index point and refracted angle
VW	50441	<ul style="list-style-type: none"> Step block for calibrating thickness range Eight .039 in (1 mm) steps, .039 in (1 mm) through .039 in (9 mm) to .315 in (8 mm)
N30	58474	<ul style="list-style-type: none"> Ultrasonic reference standard Connect directly to flaw detector Produces multiple echoes at precise intervals in steel Check instrument gain over long time periods

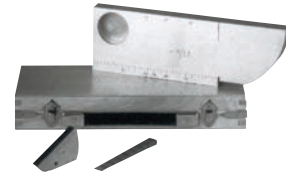

Calibration Blocks—North American Standards

Block Type (Steel)	Order Code	Description
IW Type 1	118-540-270	<ul style="list-style-type: none"> Large angle beam calibration block 4.0 in (101.6 mm) radius for angle beam range calibration Measure beam index point and refracted angle Also used to check resolution and sensitivity
IW Type 2	118-540-280	<ul style="list-style-type: none"> Same as IW Type 1 with 2 in (50.8 mm) and 4 in (101.6 mm) radii for range calibration Side drilled holes also added for resolution check
DSC	118-540-300	<ul style="list-style-type: none"> Small block for angle beam distance and sensitivity calibration 1.0 in (25.4 mm) radius opposite a 3.0 in (76.2 mm) radius 0.375 in (9.5 mm) slot in the 3.0 in (76.2 mm) radius Also used to check beam index point and refracted angle
Angle Beam, Miniature	118-540-260	<ul style="list-style-type: none"> Substitute for DSC block 1.0 in (25.4 mm) radius opposite a 2.0 in (50.8 mm) radius Side drilled hole to check beam index point and refracted angle
AWS Resolution	118-540-350	<ul style="list-style-type: none"> Evaluate angle beam transducer resolution capability Three sets of side drilled holes for 45°, 60° and 70° angles Three 0.062 in (1.6 mm) diameter holes in each set of holes
NAVSHIPS Test Block	118-540-370	<ul style="list-style-type: none"> For NAVSHIPS specification 0900-006-3010, Section 6 Distance amplitude correction, sensitivity, and flaw depth
4-Step Block	118-540-320	<ul style="list-style-type: none"> Step block for calibrating thickness range Steps .250, .500, .750, 1.00 in (6.35, 12.70, 19.05, 25.40 mm)
5-Step Block	118-540-310	<ul style="list-style-type: none"> Step block for calibrating thickness range Steps .100, .200, .300, .400, .500 in (2.54, 5.08, 7.62, 10.06, 12.70 mm)

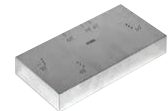

Transducer Kits

Our transducer kits combine the most commonly used transducers and accessories necessary for general, and some specific, ultrasonic testing applications. Each kit includes a hard shell carrying case for easy access, convenient storage and transportation.

Transducer Kits—European Standards

Type	Order Code	Description	Probe contents
PKS 1	57281	Coarse Grain Set	K0,5S; K1SM; WRY45; WRY70; WB45-1; WSY45-4, WSY70-4
PKS 2	57282	Aircraft Set	B4S; K4G; G5KB; MSEB4; K5K; CLF4; SEB10KF3; 2x MWB45-4; MWB70-4; MWB90-4
PKS 3	57283	Steel Set	B4S; SEB2; G5KB; MSEB4; MB4F; WK45-2; WK70-2; 2x MWB45-4; MWB70-4
PKS 4	57284	Welding Set	MB4S; SEB4; WB45-2; WB70-2; MWB45-2; 2x MWB45-4; MWB60-4; 2x MWB70-4
PKS 5	57285	Casting Set	B2S; SEB2; K1S; MB2S; SEB4KF8; G5KB; WB45-1; WB70-1; MWB45-2
PKS 6	57286	Forging Set	B4S; B2S; SEB2; MB4S; K2N; SEB4KF8; MB4F; WB45-2; MWB45-4; MWB70-4

Transducer Kits—North American Standards

Basic Contact Kit

Product Order Code 118-450-020

Wide assortment for weld inspection, lamination detection, corrosion/erosion and thin gauge materials.

Qty.	Product Codes	Description
1	113-292-603	2.25 MHz, .63 in x .63 in AWS Style, Single Element
1	113-242-591	2.25 MHz, .5 in MSW-QC Style, BMC Single Element Angle Beam Probe
1	113-262-043	2.25 MHz, 1 in CR Style, Single Element Contact Probe
1	113-544-000	5 MHz, .5 in CA211A Style, Single Element Contact Probe
1	113-252-240	2.25 MHz, .75 in PFCR Style, Single Element Membrane Probe

Qty.	Product Codes	Description
1	113-527-660	15 MHz, .25 in ALPHA 2 DFR Style, Single Element Delay Line Probe
1	113-292-751	2.25 MHz, .5 in x .5 in DU-F Style, Dual Element Contact Probe
1	113-224-681	5 MHz, .25 in RC Style, Dual Element Contact Probe
1	C-012	BNC-MD Coaxial Cable
1	C-016	BNC-BNC Coaxial Cable
1	C-024	BNC-MD Dual Coaxial Cable
1	C-088	BNC-RC Dual Coaxial Cable

Qty.	Product Codes	Description
1	D-050	Delay Lines for 113-527-660 (10 pcs.)
1	PK-140	Protective Membrane Kit for 113-252-240 PFCR probe.
1	W-104, 106	45° and 70° Lucite Wedge
1	W-211, 212, 213	45°, 60° and 70° Lucite Wedge
1	XD-740	Wedge/Delay Line Couplant
1	118-540-198	Calibration Block .1 in-.5 in
1	118-800-025	Diced Foam Carrying Case

Basic AWS Weld Inspection Kit

Order Code 118-450-500

Transducers and accessories for testing weldments to specification AWS D1.1.

Qty.	Product Codes	Description
1	113-292-603	2.25 MHz, .63 in x .63 in AWS Style, Single Element Angle Beam Probe
1	113-292-601	2.25 MHz, .63 in x .75 in AWS Style, Single Element Angle Beam Probe
1	113-292-604	2.25 MHz, .75 in x .75 in AWS Style, Single Element Angle Beam Probe
1	113-262-043	2.25 MHz, .1 in dia. CR-RHP, L-Wave Contact Probe
1	W-104	45° Lucite Wedge
1	W-105	60° Lucite Wedge
1	W-106	70° Lucite Wedge
1	C-016	BNC-BNC Coaxial Cable
1	B-196	DSC Reference Standard
1	XL-820	8 oz. Couplant
1	118-800-025	Diced Foam Carrying Case

Multi-Purpose Contact Kit

Order Code 118-450-510

Commonly used transducers for a variety of angle beam, lamination, corrosion, general flaw, and thickness testing.

Qty.	Product Codes	Description
1	113-544-000	5 MHz, .5 in dia. CA211A Style, Single Element Contact Probe
1	113-262-043	2.25 MHz, 1 in dia. CR Style, Single Element Contact Probe
1	113-527-660	15 MHz, .25 in Alpha 2 DFR Style, Delay Line Probe
1	113-224-700	5 MHz, .25 in dia. ADP Style, Dual Element Probe
1	113-244-591	5 MHz, .5 in dia. MSW-QC Style, Benchmark Angle Beam Probe
2	W-211	45° Lucite Wedge
2	W-212	60° Lucite Wedge
2	W-213	70° Lucite Wedge
2	C-016	BNC-BNC Coaxial Cable
2	C-012	BNC-MD Coaxial Cable
1	118-540-198	5 Step Reference Standard, 1 in-.5 in
1	XL-820	8 oz. Couplant
1	118-800-025	Diced Foam Carrying Case

Basic Angle Beam Kit

Order Code 118-450-030

Assortment for weld and other angle beam inspections.

Qty.	Product Codes	Description
1	113-294-642	5 MHz, 70° ABFP-SM, Single Element Angle Beam Probe
1	113-216-585	10 MHz, .125 in SMSWS Style, Single Element Angle Beam Probe
1	113-294-600	5 MHz, 5 in x 1 in SWS Style, Single Element Angle Beam Probe
1	113-224-591	5 MHz, .25 in MSWQC-Style, Benchmark Angle Beam Probe
1	118-540-196	DSC Reference Standard
1	C-047	BNC-MMD Coaxial Cable
1	C-016	BNC-BNC Coaxial Cable
1	C-012	BNC-MD Coaxial Cable
1 ea.	W-120, 122	45° and 70° Lucite Wedge
1 ea.	W-015, 017	45° and 70° Lucite Wedge
1 ea.	W-201, 202, 203	45°, 60° and 70° Lucite Wedge
1	XL-820	8 oz. Couplant
1	118-800-025	Diced Foam Carrying Case

Tables and Formulas

dB vs. Amplitude Ratio Chart

dB	Ratio	dB	Ratio	dB	Ratio	dB	Ratio
0	1.00:1	5	1.78:1	11	3.55:1	17	7.08:1
.5	1.06:1	6	2.00:1	12	3.98:1	18	7.94:1
1	1.12:1	7	2.24:1	13	4.47:1	19	8.91:1
2	1.26:1	8	2.51:1	14	5.01:1	20	10.00:1
3	1.41:1	9	2.82:1	15	5.62:1	40	100.00:1
4	1.58:1	10	3.16:1	16	6.31:1	60	1000.00:1

Near Field Length (N) in Water

Frequency (MHz)	Element Diameter							
	mm 25.4	(in) (1.0)	mm 19.1	(in) (0.75)	mm 12.7	(in) (0.50)	mm 6.3	(in) (0.25)
1.0	109.2	(4.3)	61	(2.4)	27.2	(1.07)	6.8	(0.27)
2.25	243.8	(9.6)	137.1	(5.4)	61.0	(2.4)	15.3	(0.60)
5.0	543.5	(21.4)	304.8	(12.0)	137.1	(5.4)	33.0	(1.3)
10.0	1092.2	(43)	609.6	(24)	(271.8)	(10.7)	68.6	(2.7)

To find approx. length in steel, divide the above values by 4.

Velocity and Acoustic Impedance of Common Materials

Material	Longitudinal Velocity		Shear Velocity		Acoustic Impedance MRayl
	in/s x 10 ⁶	km/s	in/s x 10 ⁶	km/s	
Air	.013	.33	-	-	.0004
Aluminum	.25	6.3	.12	3.1	17.0
Aluminum Oxide	.39	9.9	.23	5.8	32.0
Beryllium	.51	12.9	.35	8.9	23.0
Boron Carbide	.43	11.0	-	-	26.4
Brass	.17	4.3	.08	2.0	36.7
Cadmium	.11	2.8	.059	1.5	24.0
Copper	.18	4.7	.089	2.3	41.6
Glass (Crown)	.21	5.3	.12	3.0	18.9
Glycerin	.075	1.9	-	-	2.42
Gold	.13	3.2	.047	1.2	62.6
Ice	.16	4.0	.08	2.0	3.5
Inconel	.22	5.7	.12	3.0	47.2
Iron	.23	5.9	.13	3.2	45.4
Iron (Cast)	.18	4.6	.10	2.6	33.2
Lead	.085	2.2	.03	.7	24.6
Magnesium	.23	5.8	.12	3.0	10.0
Mercury	.057	1.4	-	-	19.6
Molybdenum	.25	6.3	.13	3.4	64.2
Monel	.21	5.4	.11	2.7	47.6
Neoprene	.063	1.6	-	-	2.1

Material	Longitudinal Velocity		Shear Velocity		Acoustic Impedance MRayl
	in/s x 10 ⁶	km/s	in/s x 10 ⁶	km/s	
Nickel	.22	5.6	.12	3.0	49.5
Nylon, 6-6	.10	2.6	.043	1.1	2.9
Oil (SAE 30)	.067	1.7	-	-	1.5
Platinum	.13	3.3	.067	1.7	69.8
Plexiglass	.11	2.7	.043	1.1	3.1
Polythylene	.07	1.9	.02	.5	1.7
Polystyrene	.093	2.4	.04	1.1	2.5
Polyurethane	.070	1.9	-	-	1.9
Quartz	.23	5.8	.087	2.2	15.2
Rubber, Butyl	.07	1.8	-	-	2.0
Silver	.14	3.6	.06	1.6	38.0
Steel, mild	.23	5.9	.13	3.2	46.0
Steel, stainless	.23	5.8	.12	3.1	45.4
PTFE	.06	1.4	-	-	3.0
Tin	.13	3.3	.07	1.7	24.2
Titanium	.24	6.1	.12	3.1	27.3
Tungsten	.20	5.2	.11	2.9	101.0
Uranium	.13	3.4	.08	2.0	63.0
Water	.0584	1.48	-	-	1.48
Zinc	.17	4.2	.09	2.4	29.6

Useful Formulas

Near Field Length	$D^2F/4C$ or $D^2/4\lambda$
Beam Spread	$SIN_\gamma C/DF \times 1.22$ or $1.22\lambda/D$
Snell's Law	$SIN\alpha / SIN\beta = C_1/C_2$
Skip Distance	$2T \times TAN\beta$
V-Path	$2T/COS\beta$
Surface Distance (Projected)	$S.P. \times SIN\beta$
Depth (1st Leg)	$S.P. \times COS\beta$
Depth (2nd Leg)	$2T - (S.P. \times COS\beta)$
Depth (3rd Leg)	$(S.P. \times COS\beta) - 2T$
Wavelength	C/F
Frequency	C/λ
Acoustic Impedance	$Z = C \times d$
% of Reflected Sound Pressure	$R_p = (Z_2 - Z_1)/(Z_2 + Z_1)$
Coefficient of Transmission	$T_p = 2Z_2/(Z_2 + Z_1)$
Total Beam Width	$TBW = (Depth - N) (2TAN_\gamma) + T \times \text{Element Diameter}$

Transit Time	$TT = 2T/C$
Center Frequency	$F_c = (F_1 + F_2)/2$
% Bandwidth	$(F_1 - F_2)/F_c \times 100\%$
Q Factor	$F_c/(F_1 - F_2)$
Distance	Speed x Time
RPM	Speed/Circumference
Maximum Scanning Speed (x, y)	(Min. Flaw Length + EBW) x PRR
Maximum Scanning Speed (polar)	RPM x Diameter x Clock interval (ft per min.)
dB Difference	$20 \text{ Log } (A1/A2)$
dB Ratio	$Inv \text{ log } dB/20$
Water Equivalent = (Steel)	$WE = F(\text{water}) \times (C(\text{water})/C(\text{steel}))$ (F = Focal length)
MAXB	$SIN^{-1}(ID/OD)$
Focal Length	$R = F(n - 1)/n$
Cylinder Offset Technique	Offset (X) = Outside Radius x SINα

Symbol Key

λ	= Wavelength
D	= Probe Diameter
F	= Probe Frequency
C	= Acoustic Velocity
d	= Density
α	= Incident Angle
β	= Refracted Angle
T	= Part Thickness
S.P.	= Sound Path
N	= Near Field
γ	= Divergence 1/2 Angle

GE Sensing & Inspection Technologies couples a legacy of more than 130 years of GE leadership and innovation with world-class technology from the leading names in ultrasonic nondestructive testing—AGFA NDT, Krautkramer and Nutronik.

GE

Sensing & Inspection Technologies

GE Sensing & Inspection Technologies provides technology-driven inspection solutions that deliver productivity, quality and safety. We design, manufacture and service ultrasonic, remote visual, radiographic and eddy current equipment to inspect, monitor and test materials and equipment without disassembling, deforming or damaging them.

We offer specialized products and services that will help improve productivity in a wide range of industries including aerospace, power generation, oil and gas, automotive and metals.

Ultrasonic

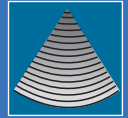

Radiography



Hardness Testing

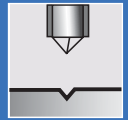

Eddy Current

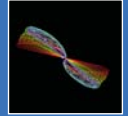

Remote Visual



Metrology

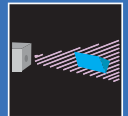

Software

